

Thank you for purchasing our product.
Please read this User's Manual before
using the product. Change without Notice

16 Channel Digital Video Recorder

User's Manual

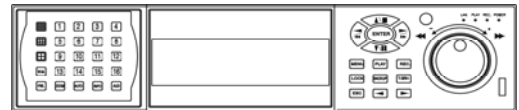

Safety Precautions

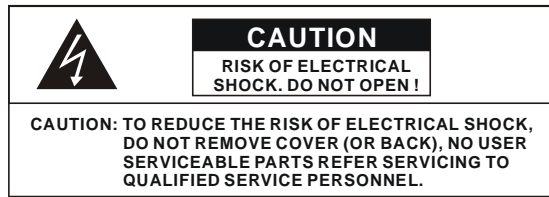

This label may appear on the bottom of the unit due to space limitations.



The lightning flash with arrowhead symbol, within an equilateral triangle, is intended to alert the user to the presence of insulated dangerous Voltage within the product's enclosure that may be sufficient magnitude to constitute risk of electrical shock to persons.



The exclamation point within an equilateral triangle is intended to alert the user to the presence of important operation and maintenance (servicing) instructions in the literature accompanying the appliance.

WARNING: TO PREVENT FIRE OR SHOCK HAZARD, DO NOT EXPOSE UNITS NOT SPECIFICALLY DESIGNED FOR



Attention: installation should be performed by qualified service Personnel only in accordance with the National Electrical Code or applicable local codes.



Power Disconnect. Units with or without ON-OFF switches have power supplied to the unit whenever the power cord is inserted into the power source; however, the unit is operational only when the ON-OFF switch is the ON position. The power cord is the main power disconnect for all unites.



“CAUTION: Danger of explosion if battery is incorrectly replaced.

Replace only with the same or equivalent type recommended by the manufacturer. Dispose of used batteries according to the manufacturer's instruction.”

Warranty
and Service

During the warranty period (one year), we will repair or replace the DVR free of charge.

Be sure to have the model number, serial number and vendor stick on hard disk for service representative.

About this document

Before installing stand alone DVR, be sure to thoroughly review and follow the instructions in this Users Manual. Pay particular attention to the parts that are marked **NOTICE**.

Also, when connecting with external application, first turn the power OFF and follow manual instruction for appropriate installation.

Before reading this document

1. This document is intended for both the administrator and users of stand alone DVR Model.
2. This manual contains information for configuring, managing and using stand alone DVR Model.
3. To prevent fire or electrical shock, do not expose the product to heat or moisture
4. Be sure to read this manual before using stand alone DVR Model.
5. For questions and technical assistance of this product, contact your local dealer.

► Strong recommendation on installation of the DVR unit

1. Check electricity at the place you want to install the DVR unit is stable and meets our electricity requirements.

Unstable electricity will cause malfunction of the unit or give critical damage to the unit.

2. Several chips on the main board of the DVR unit and hard disk drive inside the unit generate heat, and it must be properly discharged.

Do not put any objects just beside exhaust port(fan) on the left side of the unit and do not close up an opening (fresh air in-take) on the right side of the unit..

3. Put the DVR unit at well-ventilated place and do not put heat-generating objects on the unit.

When it is installed inside 19 inch mounting rack together with other devices, please check built-in ventilation fan of the rack is properly running.

Content

Safety Precautions.....	2
About this document.....	3
Before reading this document.....	3
Unit Description of Front Panel.....	5
Unit Description of Rear Panel.....	6
Installation.....	7
Function Setup.....	15
Login.....	15
Basic Operation.....	16
USB Data Read and Networking.....	39
Record Time Table: 80 GB HD.....	49
VGA Description (Optional)	50
Additional.....	51

Unit Description of Front Panel

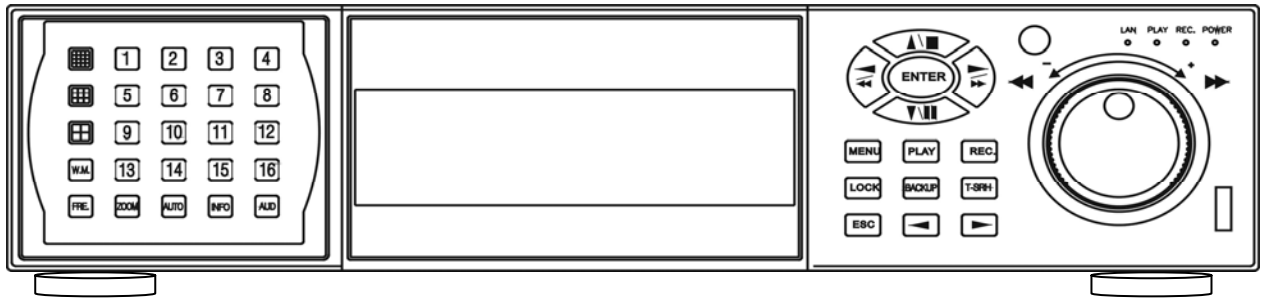

16 / 9 / 4 split screen



1 ~ 16 full screen



Water Mark function



Freezer / Zoom / Sequence / Information / Audio

MENU :

Menu button

PLAY :

Play button

REC :

Record button

LOCK :

Key lock button

BACKUP :

Data back up button

T-SRH :

Time search playback button

ESC :

Function exit button



Value change button



Direction UP / Down,
Record and play stop,
Playback pause / steps.

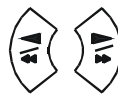

Direction Left / Right
Playback forward or reverse.



ENTER

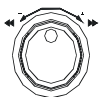

Playback forward / reverse
Function item change shuttle.

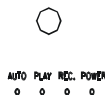

Remote controller IR
Function LED light display



USB. Data backup or firmware update

Unit Description of Rear Panel

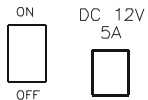
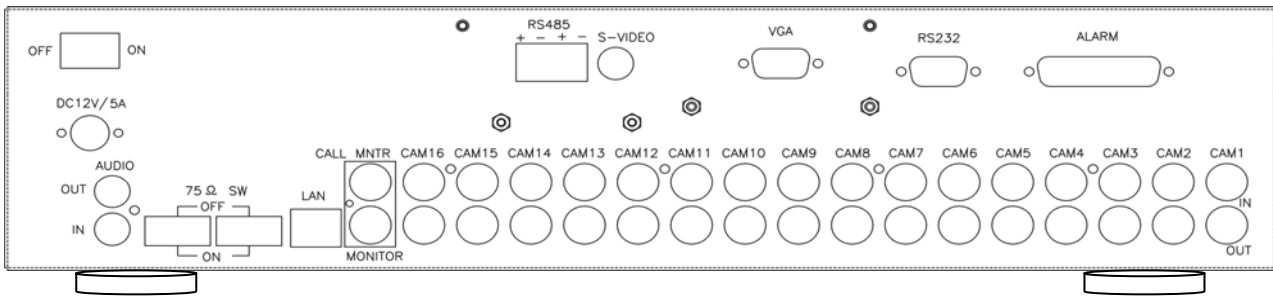

Power cord in 12V/5A, power switcher (ON / OFF)

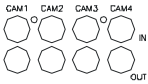

Camera 1 ~ 16 in and looping out



75 Ohm ON/OFF (high/low adjust)



Audio channel input x 1 and output x 1



Main Monitor



S-Video (Y/C) monitor



VGA output. PC monitor connector. (Optional)



RS-485 control keyboard connector



RS-232 connector (ISP. For RD control)

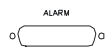

Alarm connector



LAN

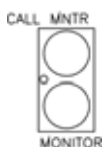

Call Monitor. Channel sequence 1 ~ 16.
Stop on full channel when event happens.

Installation

Procedure

1) Camera Connection

Connect the camera to the CAMERA INPUT on the Rear Panel of the 16 CH DVR.

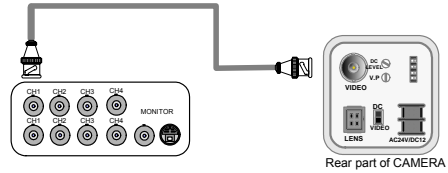

2) Monitor Connection (Composite Connection Method)

Connect the monitor to the MONITOR OUT on the Rear Panel of the 16 CH DVR.

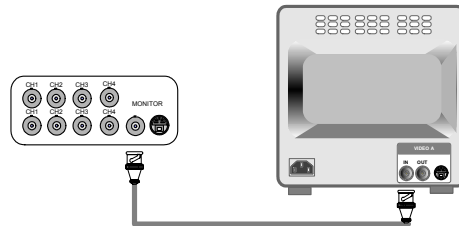

3) Monitor Connection

Connect S-VIDEO Monitor to MONITOR OUT on the Rear Panel of the 16 CH DVR.

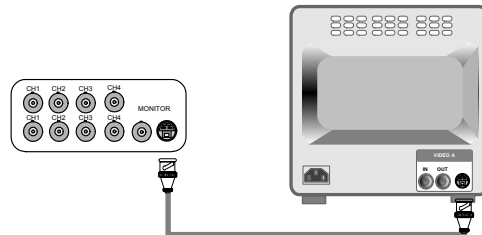

4) Sensor Connection

Connect the Sensor to the SENSOR INPUT/OUTPUT on the Rear Panel of the system

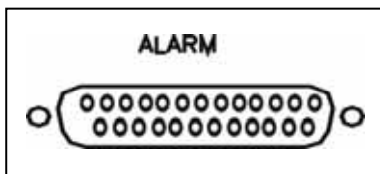

13,12,11,10,9,8,7,6,5,4,3,2,1

25,24,23,22,21,20,19,18,17,16,15,14

- | | |
|--------------|---------------|
| 1. ALARM 1 | 14. ALARM 13 |
| 2. ALARM 2 | 15. ALARM 14 |
| 3. ALARM 3 | 16. ALARM 15 |
| 4. ALARM 4 | 17. ALARM 16 |
| 5. ALARM 5 | 18. X |
| 6. ALARM 6 | 19. X |
| 7. ALARM 7 | 20. DGND |
| 8. ALARM 8 | 21. ALARM COM |
| 9. ALARM 9 | 22. ALARM NC |
| 10. ALARM 10 | 23. ALARM NO |
| 11. ALARM 11 | 24. DGND |
| 12. ALARM 12 | 25. DGND |
| 13. DGND | |

Relay output : COM+NC, COM+NO

Alarm input : Short-circuit between Alarm1 ~ 16 and GND is recognized as alarm by default.

Alarm 1 ~ 16 will be corresponding to Camera 1 ~ 16.

NC = Normal Close. NO = Normal Open.

NOTICE: Sensor input is RECOGNIZED as LOW when alarm signal is on a level with GND, and it is recognized as HIGH when alarm signal is FLOATING or 5V. Following is internal circuit.

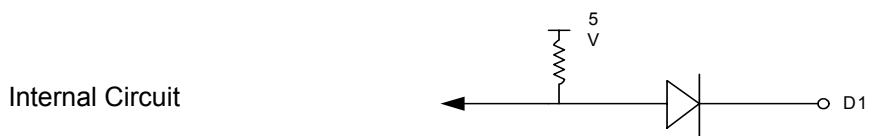

Thus, there is a danger of damage, when the sensor input goes to a Negative level or voltage higher than 5V.

5) Network Connection

DVR connects to LAN

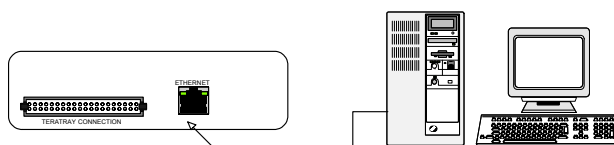

To view video image on the computer through internet with DVR view software.

5) HDD connection

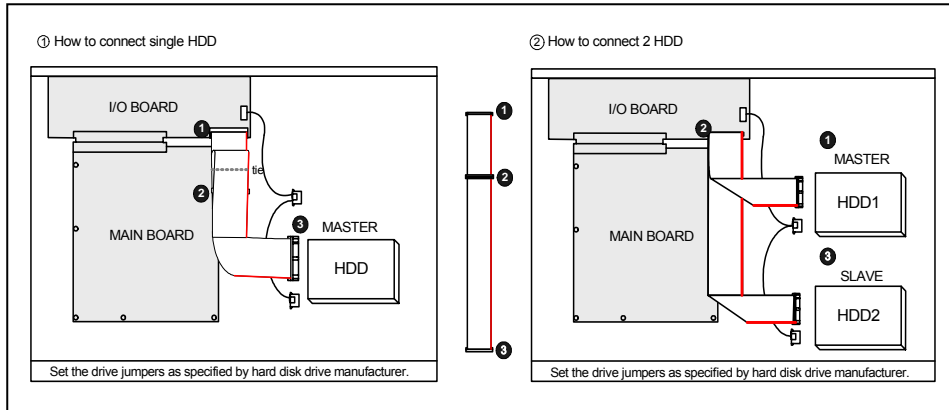

1. Make sure the HDD is MASTER.
2. Make sure the cable connector is correct.
3. Please check the HDD panel for Master set up.

1. Make sure the HDD is MASTER and SLAVE.
2. Make sure the cable connector is correct.
3. Please check the HDD panel for Master and Slave set up.

Notice:

-The 16 ch DVR provides 2 internal hard drives. We provide one hard disk drive with removable rack; the other one is fixed designed.

- We recommend you to set the Removable Hard Disk as Slave. Set another one as the Master.

-Hard Disk Master and Slave jumper pin must right, otherwise it makes DVR work fault.

Hard Disk testing table:

Brand	Model	Capacity	Notice
Seagate	Barracuda	80 GB	
IBM	DeskStar	80 GB	
WD2000	Caviar	200 GB	
Hitachi	DeskStar	80 GB	
Maxtor	MaxLinell	300 GB	



Full screen or split screen display

Press button, to display 16 / 9 / 4 quarterly split screen.

Press numeric buttons to display the desired camera image in full screen.

1.) FREEZE Mode

1. In live mode press (FREEZE) button to freeze image.

2. Press again to cancel freeze mode.

2.) Zoom Mode(Display Enlargement.)

Go to full screen mode with numeric buttons at live or playback mode, then press ZOOM button to display screen Enlargement.

Use button to move position.

3.) Auto Mode

Press (AUTO) button to start screen auto sequencing, and press it again to cancel auto mode.

4.) W.MARK. Water Mark mode.

Water Mark on to check if the data has modify.

5.) INFO (System Information). Auto disappear after 2 minutes if no any button operating.

**** SYSTEM INFORMATION ****
1.IP ADDR:
2.GATEWAY:
3.NETMASK:
4.NET USER:
5.HDD SIZE:
6.HDD USED:
7.STATUS1
8.STATUS2
9.UPTIME
10.VERSION:

- 1. Network IP address
- 2. Network IP gateway
- 3. Network IP netmask
- 4. Network user amount
- 5. Hard disk capacity
- 6. Hard disk used percentage
- 7. First hard disk status
- 8. Video format
- 9. System running time
- 10. System version

6.) BACKUP. Image backup mode.(Image back up must be done on playback mode only.)

Locate the playback point of which you want. Press BACKUP, the BACKUP CAUTION window pop-up. Press ENTER to begin data back up. Capacity of USB device is not limit.

On playback mode, presses BACKUP:

Lower-Right corner of the screen:

** BACKUP CAUTION **
THE ORIGINAL BACKUP FILE
WILL BE KILLED.
PRESS [ENTER] TO BACKUP.
PRESS [BACKUP] TO CANCEL.

xxx K

xxx K (Presently back up progress)

Important:

If DVR cannot detect USB device, please format it to FAT or FAT 32 on PC OS.

Additional:

During playback, USB device is full or user press BACKUP button screen display a “PAUSE” caption, User takes out the USB device to computer USB slot then save data to hard disk. After re-insert USB device to DVR slot, user press BACKUP again. Press ENTER to continue backup or backup button to cancel.

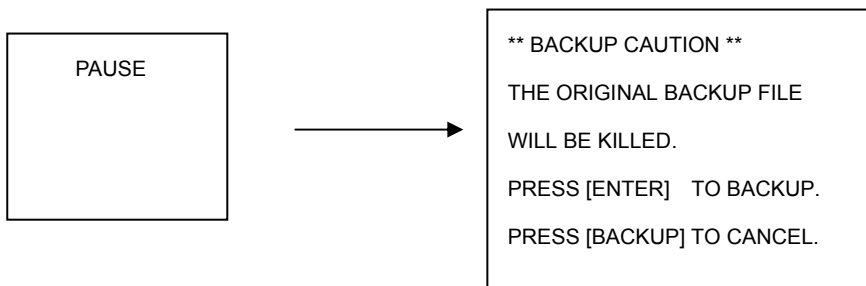

PS: NetViewer 16 CH software auto copies to USB device when data backup. See the USB Data Read and Networking pages.

Compatible USB: Transcend 256 MB, 1 GB / A-DATA, 512MB / USB Flash Drive 128 MB / Intelligent Stick 256 MB / SOLOMON 128 MB / ISTECH 1GB.

7.) Key Lock function

>On the Live mode, press  (lock), Only, numeric, freeze, auto, and zoom buttons could work. Press lock key again to enter the login-in window. Enter admin or user password to unlock. Key lock function only accept password correct log in even re-boot DVR power.

8.) AUDIO function))))

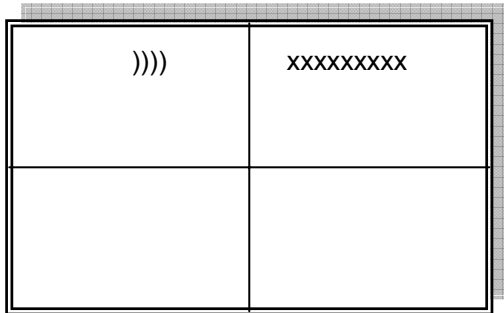

Audio playback: **AUD** (Audio),
))))) displays on the Upper-left of screen. At that time, audio will playback. Press it again to turn it off.

Notice

Audio playback only on normal(x 1) playback.

9. NETWORK Playing

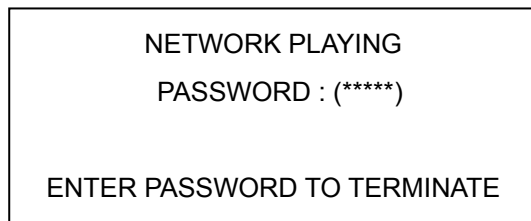

1. When the admin do playback mode on AP (Net Viewer), user can terminate it after into password of DVR.
On AP client, admin needs to connect again.

2. When AP on playback mode, DVR is on playback mode also.

Playback

1. Playback Mode

- 1) Press  button to begin playback. (System playback the images backward)

2. T-SRH button

- 1) T-SRH: Playback by time search.
Press T-SRH button to active playback function.

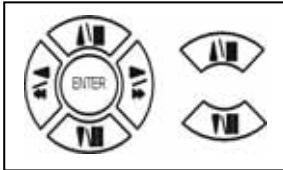

Press direction button
UP/DOWN to choose
items.

MAIN PLAY PAGE

- 1.MASTER TIME LIST
- 2.SLAVE TIME LIST
- 3.MASTER EVENT LIST
- 4.SLAVE EVENT LIST
- 5.GOTO DATE: 2004/12/31
- 6.GOTO TIME: 12:12
- 7.GOTO PLAY

1) TIME LIST (Playback image by Time-Search): Recorded images list (by hours)

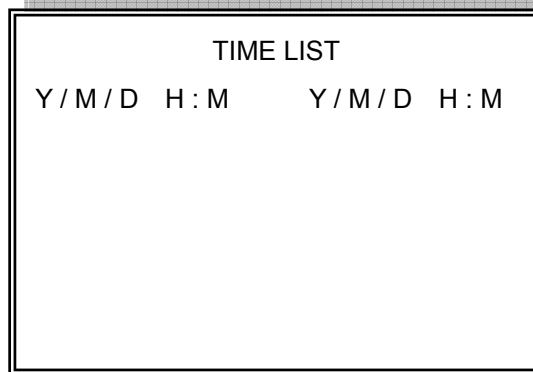

Y / M / D H : M (Beginning of recording time) Y / M / D H : M (End of recording time)

Every playback data list displays by an hour.

No page display limit. 10 items display on each page.

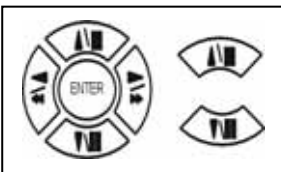

Press direction button UP/DOWN to choose items.

Press ◀ ▶ values change button to change to previous / next page.

Notice:

Every playback data list displays by an hour, but if user finds out like:

1. 10:00 ~ 10:12
2. 10:12 ~ 11:00

Reason: 1. Hard disk is full. 2. User change record mode setup.

2) EVENT LIST (Alarm List): Event source- Video loss / Alarm trigger / Motion / Record

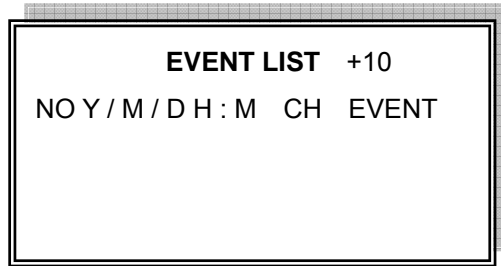

10 items display on each page / Total 5000 items display for 500 pages. When event list is out of compass, the total items are less than 5000.

NO Y / M / D H : M CH EVENT

>Event happens time and list.

CH: Event Channel Display.

>1 CH ~ 16 CH

+10 : Display pages by 10 units / +100 : Display pages by 100 units / +1000 : Display pages by 1000 units.

- Press direction button left and right to change +10 / +100 / +1000

Event type.

>Includes Motion / Alarm / V-Loss / Record / Power On / Event Full / Network (Network total users, include log in and log out.)

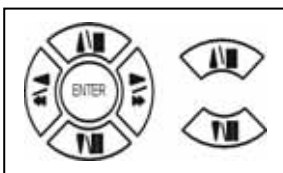

Press direction button UP/DOWN to choose items.

Press ◀ ▶ values change button to change page. Press ENTER to start playback.

>Special time search playback:

Go TO DATE : 2 0 0 2 / 1 2 / 1 2

-Choose year / month / day

>Press direction button Left / Right to choose items, press values change button ◀ ▶ to change value.

GOTO TIME : 1 2 : 1 2

-Choose hour and minute

>Press direction button Left / Right to choose items, press values change button ◀ ▶ to change value.

GOTO PLAY

-Press ENTER button to start playback.

Notice: Playback speed change by ◀ ▶ or shuttle. Speed is x 1, x 2, x 4, x 8, x 16.

Function Setup

LOGIN

- 1) Press  button to enter into menu. You could do the system function setup in MENU.
- 2) Password enter window pop-up:

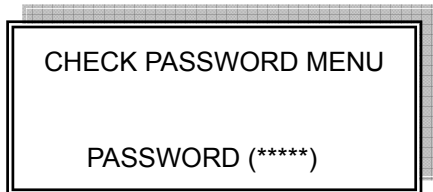

Default password (Account-Admin) : 44444

Default password (Account-User) : 11111

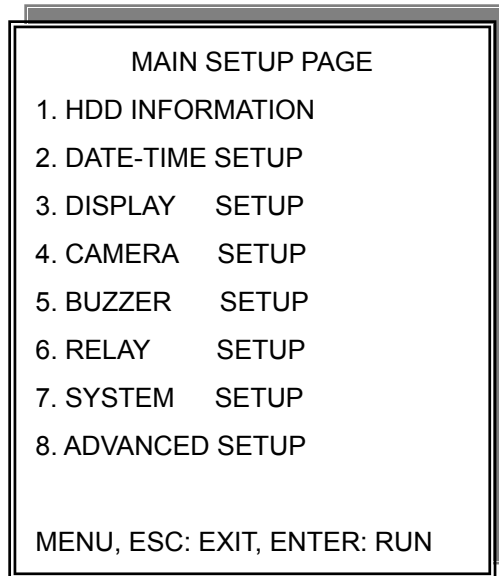

- 3) Press numeric (1 ~ 10)button or remote controller (1 ~ 10)to choose password.
- 4) Remote controller function buttons are same as DVR panel function buttons.

Press **MENU** button to enter **MAIN SETUP PAGE**.



1) Use direction button up/down  button to select setup item.

2) Press  button to enter into sub-menu function setup.

3) Press sub-menu item with direction button up/down  or left/right  button.

And change the value with  values change button or turn inner-shuttle.

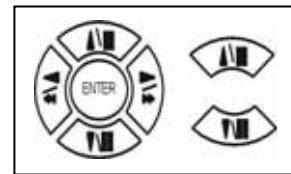

4) Press ESC to go back to main / sub menu or exit menu.

Notice:

1. ADMIN level can setup all DVR menu functions.
2. USER level cannot setup ADVANCED page of DVR main menu function.
3. Auto disappear after 4 minutes if no any button operating.

1. HDD INFORMATION

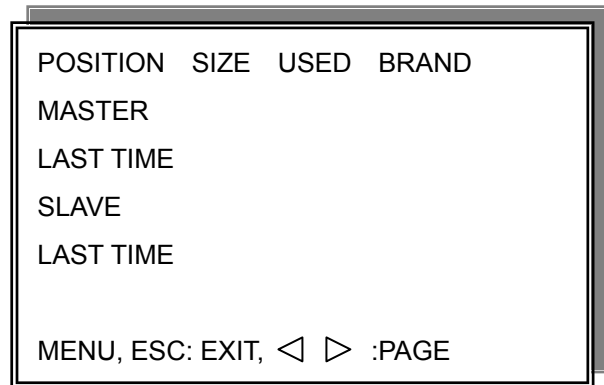
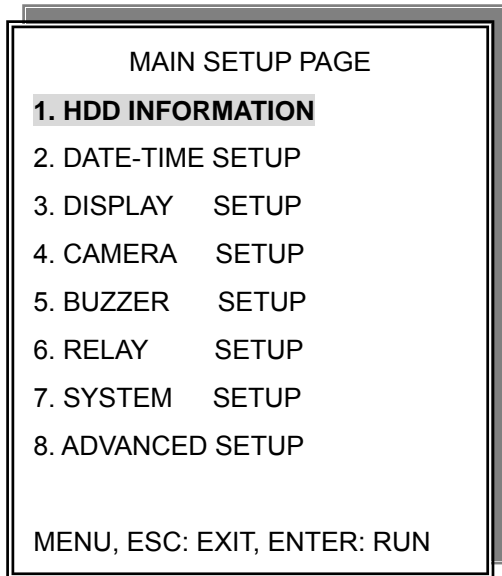

- 2 hard disk information display.

Information display: POSITION SIZE USED BRAND

>POSITION: Master / Slave

>SIZE: Hard Disk capacity. xxGB. Maximum display is 999MB

>USED: 00 ~ 100 %. Hard disk overwrites 100 ~ 199 %.

>BRAND: DVR auto detect hard disk brand.

>LAST TIME: The last record time display.

2. DATE-TIME SETUP

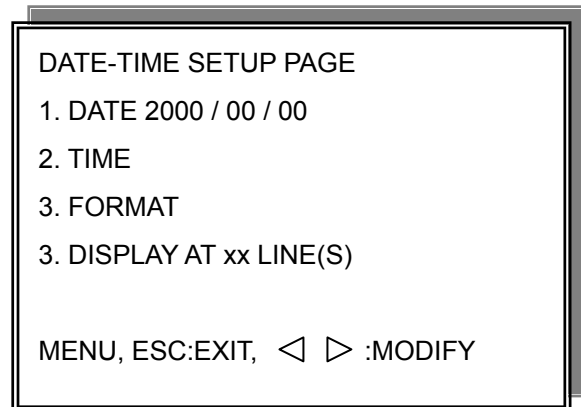
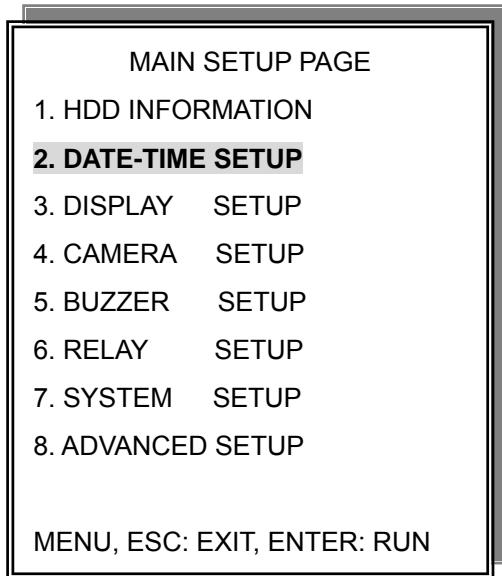

1. DATE

2. TIME: > Use direction button up/down choose position, values change button to change date and time values. Do not need to stop hard disk working (Play or record).

3. FORMAT:

YY/MM/DD, MM/DD/YY, DD/MM/YY, YY/ENG/DD, ENG/DD/YY, DD/ENG/YY, YYYY/MM/DD, MM/DD/YYYY, DD/MM/YYYY, YYYY/ENG/DD, ENG/DD/YYYY, DD/ENG/YYYY.

Y=Year. M=Month. D=Day. ENG=Month display in English.

4. DISPLAY AT xx LINE(S)

-Date and Time position on screen xx line(s). 00 ~ 23.

-. Day and time change



Press direction button up/down/left/right to choose items or move date-time position.

Press ◀ ▶ values change button to change values.

3. DISPLAY SETUP

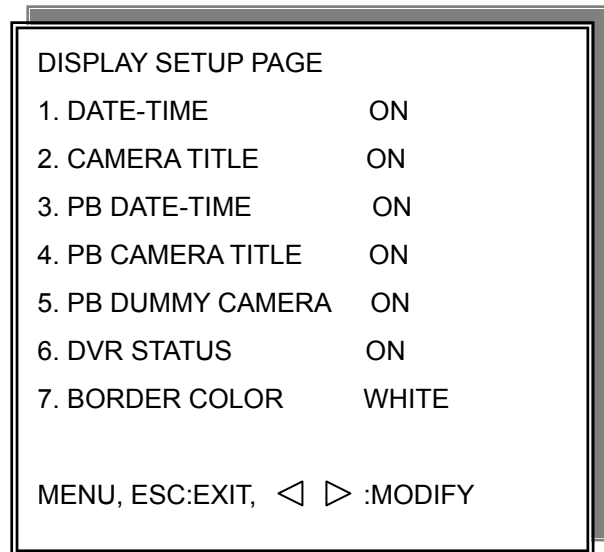
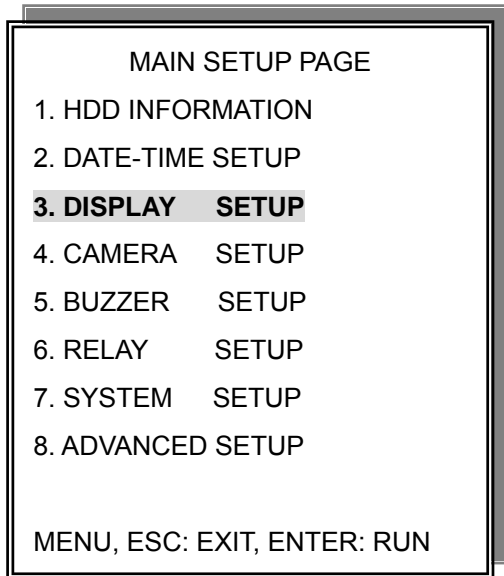

1. DATE-TIME: Date and Time caption display mode on or off setup.
>ON / OFF
2. CAMERA TITLE: Camera Title caption display mode on or off setup.
>ON / OFF
3. PB DATE-TIME: Play back date and time caption display mode on or off setup.
>ON / OFF
4. PB CAMERA TITLE: Play back camera title caption display mode on or off setup.
>ON / OFF
5. PB DUMMY CAMERA: To clear dummy image if channel input not up to 16.
>ON / OFF
6. DVR STATUS: DVR system, record, playback, audio caption display mode on or off setup.
>ON / OFF
7. BORDER COLOR: Border color WHITE / DARK / BLACK / GRAY.



Press direction button up/down to choose the desired item.

Press ◀ ▶ values change button to change values.

4. CAMERA SETUP

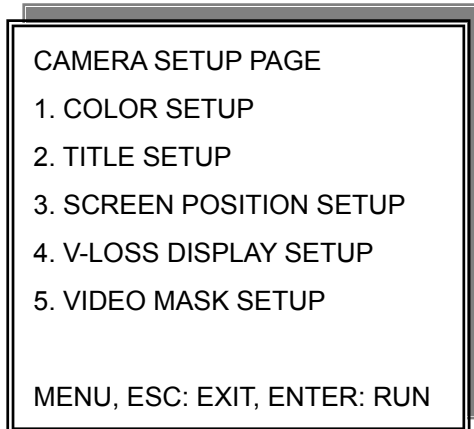
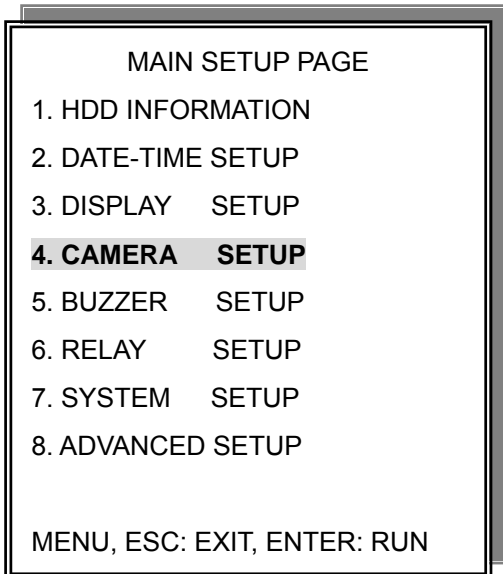

(1.) COLOR SETUP

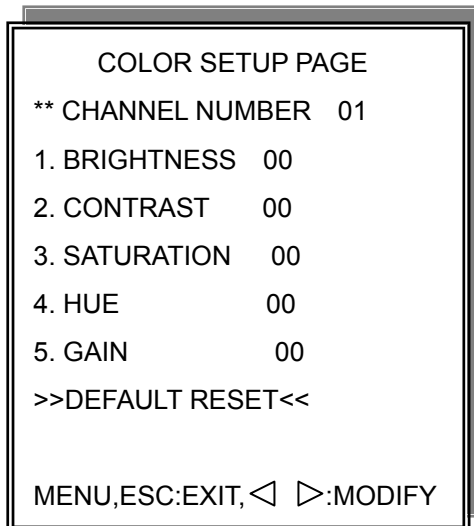
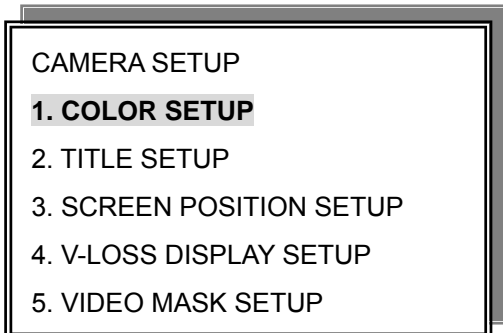

COLOR SETUP : Adjust Camera Image. Only on live mode adjustable.

CHANNEL NUMBER : Select camera 01 ~ 16

BRIGHTNESS : Adjust screen brightness (-30~ +30)

CONTRAST : Adjust color contrast (-20~ +42)

SATURATION : Adjust color saturation (-34~ +22)

HUE : Adjust color hue (-24~ +24)

GAIN : Adjust image signal level (-32~ +32)

>>DEFAULT RESET<< : Press ENTER button to reset DVR values.



Press direction button up/down to choose items.

Press < > values change button to change values.

>Right adjustment of each element in COLOR setup will increase picture quarterly displayed. We recommend you to adjust each element of COLOR SETUP for cameras and monitor to be connected to the DVR unit.

(2.) TITLE SETUP: Input TITLE of each camera. 9 characters can be input.

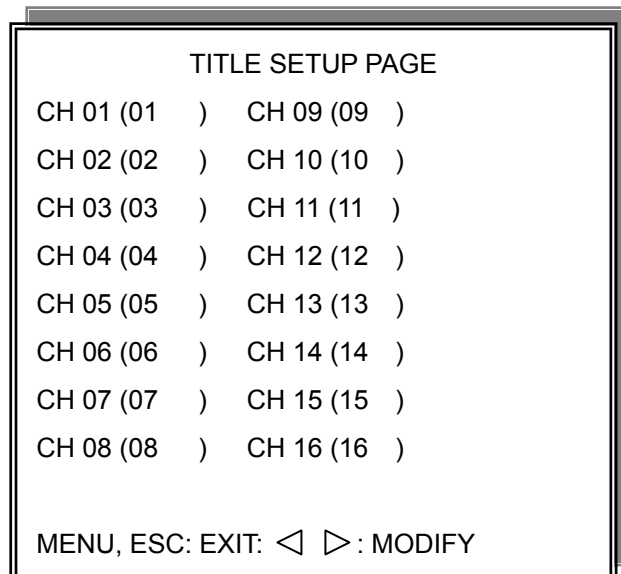
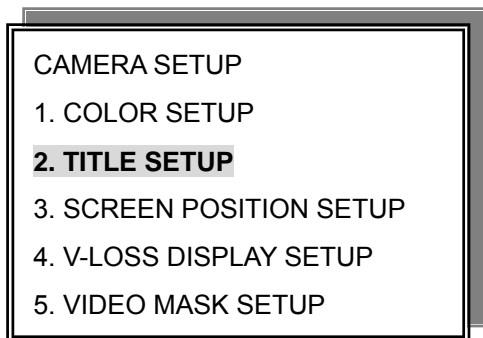

Press direction button up/down/left/right to choose items and position.

Press ◀ ▶ values change button to change values.

Characters choose:

Space:

Numeric: 0 / 1 / 2 / 3 / 4 / 5 / 6 / 7 / 8 / 9

Capital letter: A / B / C / D / E / F / G / H / I / J / K / L / M / N / O / P / Q / R / S / T / U / V / W / X / Y / Z

(3.) SCREEN POSITION SETUP

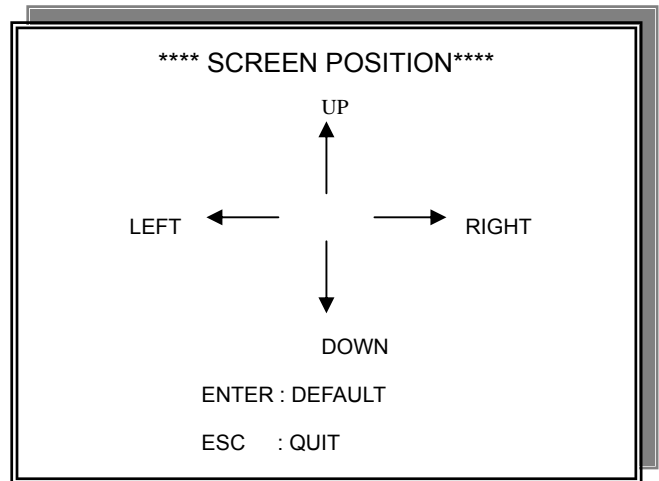
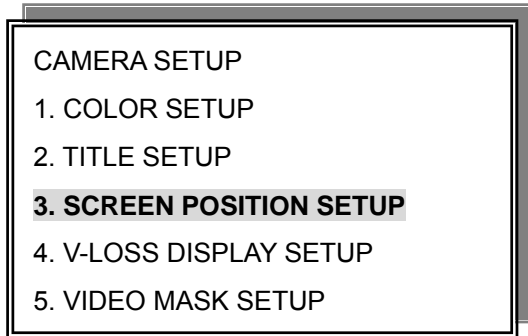

1.



Press direction buttons up/down/left/right to move screen position.

2. Press ENTER button for default.

3. Press ESC button to quit.

(4.) V-LOSS DISPLAY SETUP

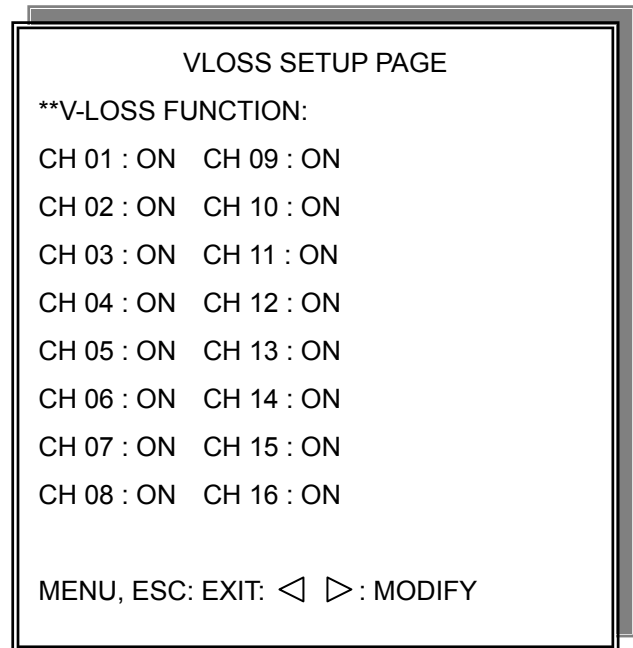
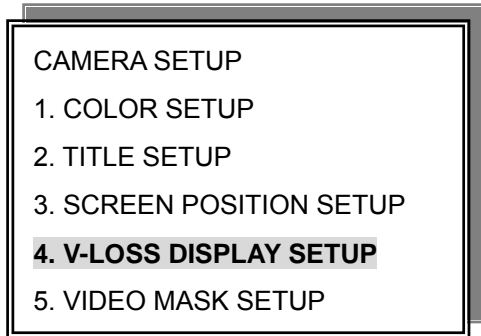

** V-LOSS FUNCTION: ON / OFF

CH 01 : ON / OFF CH 09 : ON / OFF
CH 02 : ON / OFF CH 10 : ON / OFF
CH 03 : ON / OFF CH 11 : ON / OFF
CH 04 : ON / OFF CH 12 : ON / OFF
CH 05 : ON / OFF CH 13 : ON / OFF
CH 06 : ON / OFF CH 14 : ON / OFF
CH 07 : ON / OFF CH 15 : ON / OFF
CH 08 : ON / OFF CH 16 : ON / OFF

PS. If choose on, X icon displays beside camera title.



Press direction buttons up/down/left/right to choose items.



Press values change button to change values.

(5.) VIDEO MASK SETUP

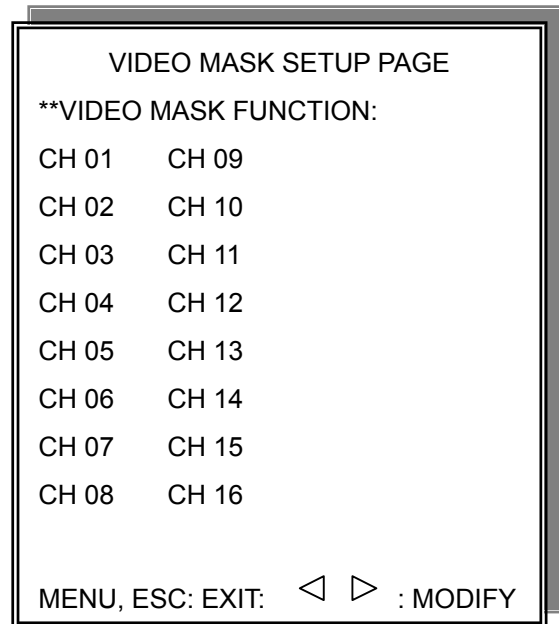
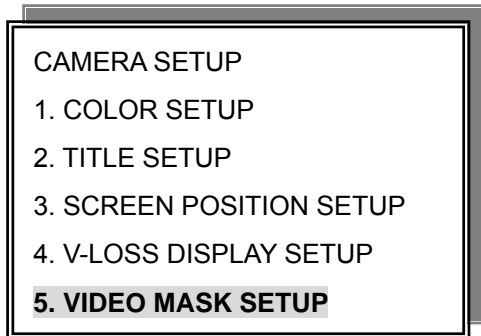

**VIDEO MASK FUNCTION: ON / OFF

CH 01 : ON / OFF CH 09 : ON / OFF
CH 02 : ON / OFF CH 10 : ON / OFF
CH 03 : ON / OFF CH 11 : ON / OFF
CH 04 : ON / OFF CH 12 : ON / OFF
CH 05 : ON / OFF CH 13 : ON / OFF
CH 06 : ON / OFF CH 14 : ON / OFF
CH 07 : ON / OFF CH 15 : ON / OFF
CH 08 : ON / OFF CH 16 : ON / OFF

MASK means the channel would not display on the live screen, but still can set it on recording.



Press direction buttons up/down/left/right to choose items.



Press values change button to change values.

5. BUZZER SETUP

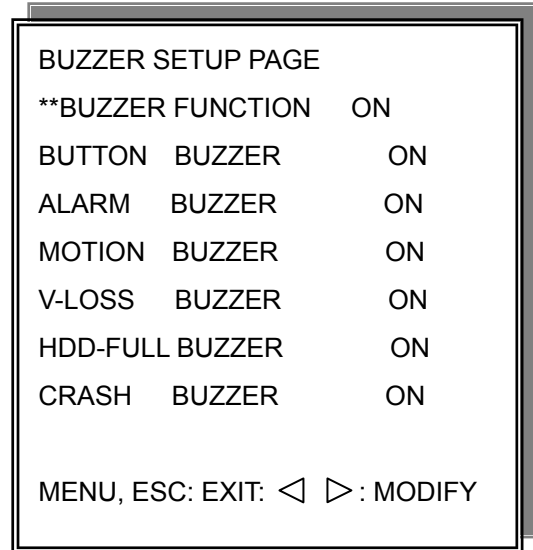
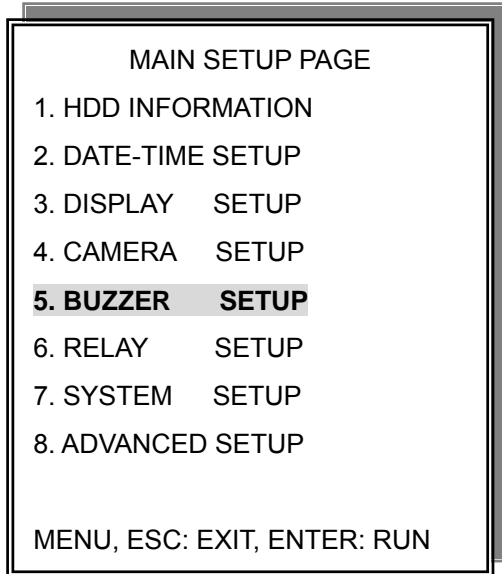

**BUZZER FUNCTION: All buzzer function

>ON / OFF

1. BUTTON BUZZER?

> ON / OFF

2. ALARM BUZZER?

> ON / OFF

3. MOTION BUZZER?

> ON / OFF

4. VLOSS BUZZER?

> ON / OFF

5. HDD-FULL?

> ON / OFF (Buzzer on if hard disk record only once(Record setup→ HDD FULL→STOP REC.)

6. CRASH?

> ON / OFF (Buzzer on if DVR system or hard disk crash.)



Press direction buttons up/down to BUZZER SETUP items.



Press values change button to change values.

6. RELAY SETUP

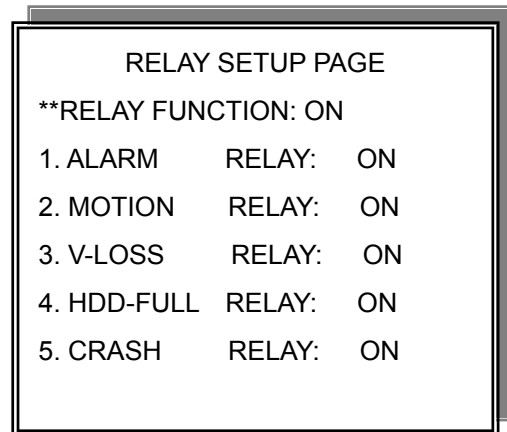
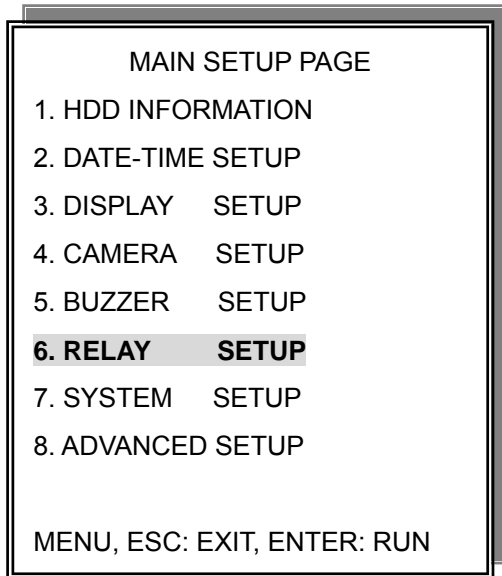

**RELAY FUNCTION: ON

- | | | |
|-------------|--------|--|
| 1. ALARM | RELAY: | ON |
| 2. MOTION | RELAY: | ON |
| 3. VLOSS | RELAY: | ON |
| 4. HDD FULL | RELAY: | ON (Relay on if hard disk record only once.)
Record setup→ HDD FULL→STOP REC. |
| 5. CRASH | RELAY: | ON (Relay on if DVR system or hard disk crash.) |



Press direction buttons up/down to each item.



Press values change button to change values.

7. SYSTEM SETUP

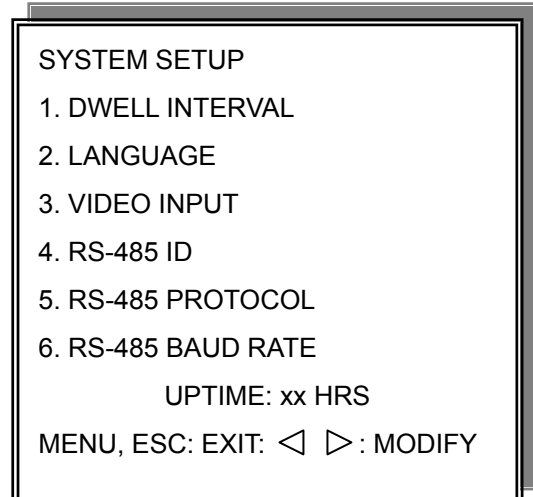
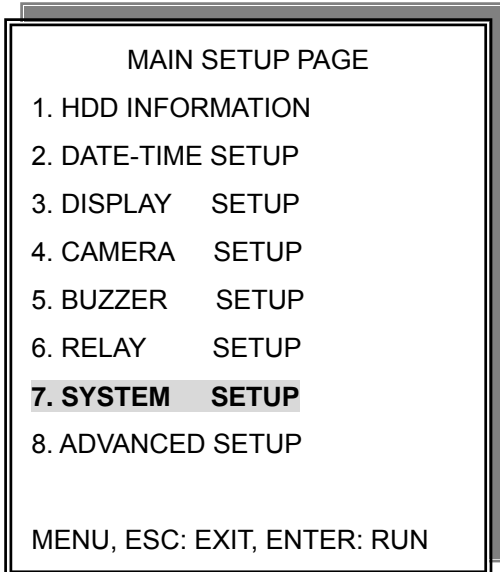

SYSTEM SETUP

1. DWELL INTERVAL:
 - 0 ~ 999SEC. Full channel and call monitor auto sequence time.
 2. LANGUAGE:
 - ENGLISH / CHINESE / JAPANESE / FRENCH
 - After change language, user needs to exit menu. Language would change next time back to menu.
 3. VIDEO INPUT: NTSC / PAL system detection.
 - AUTO / NTSC / PAL
 - User needs to re power on after change.
 4. RS-485 ID:
 - 01 ~ 16
 5. RS-485 PROTOCOL
 - KEYB / LILIN / PELCO-P / PELCO-D / NICECAM / OFF
 6. RS-485 BAUD RATE
 - 1200 / 2400 / 4800 / 9600
- UPTIME: xx HRS. This means the total system working time after DVR first power on.

RS-485 ID and protocol is the command for system control keyboard. If user has no keyboard to control then does not have to care.



Press direction buttons up/down to choose items.



Press values change button to change values.

8. ADVANCED SETUP

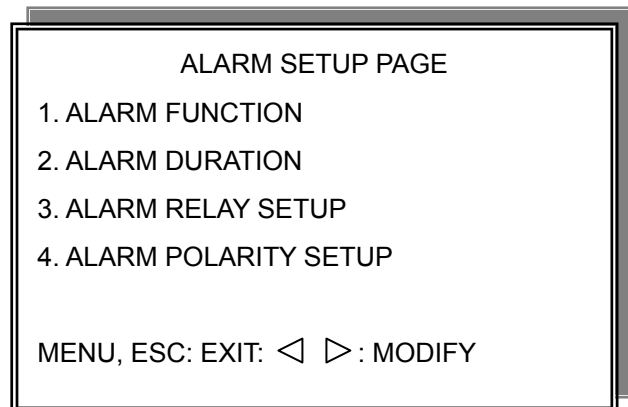
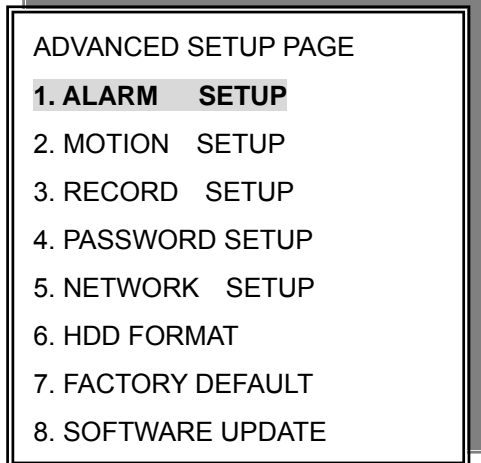
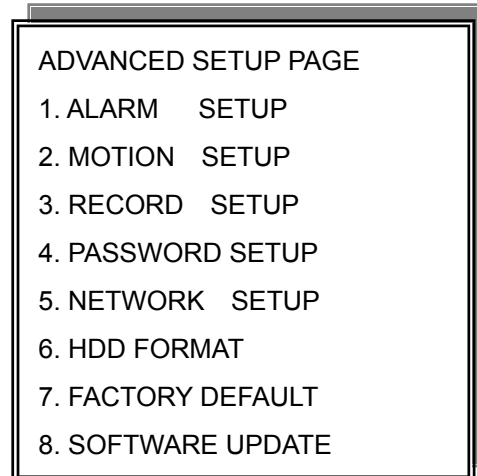
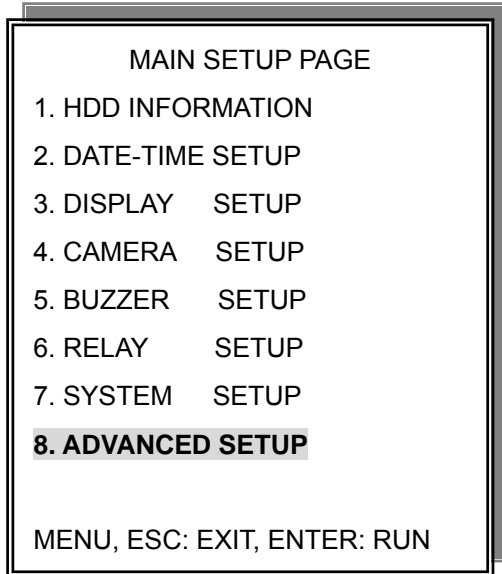

1. Alarm function: ON / OFF. Alarm function on or off depends on alarm device includes in DVR system.

2. Alarm duration: 0 ~ 999. Alarm buzzer and record duration time.

ALARM RELAY SETUP

>ALARM 01 ~ ALARM 16: ON / OFF

Even choose on, but RELAY SETUP→Alarm relay or relay function off, this function is still closed.

ALARM POLARITY SETUP

>ALARM 01 ~ ALARM 16: N.O. / N.C. / OFF



Press direction buttons up/down to choose items.



Press values change button to change values.

2. MOTION SETUP

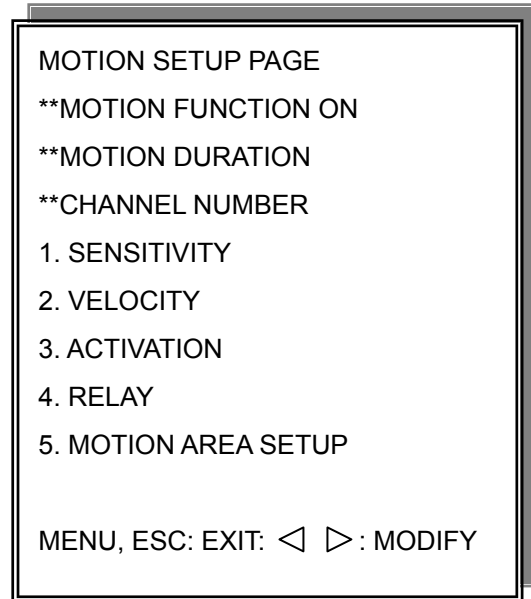
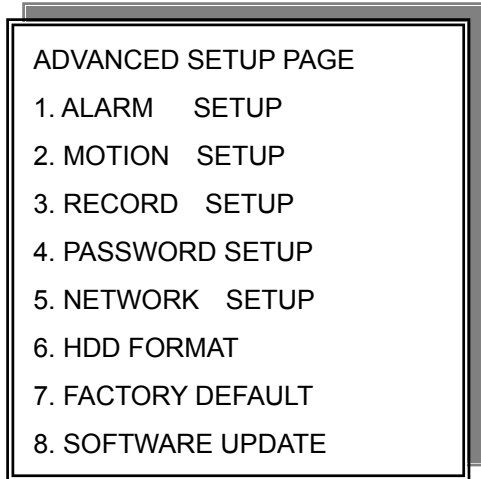

MOTION SETUP

**MOTION FUNCTION (For all channels)

-ON / OFF

**MOTION DURATION

-0 ~ 999. Motion buzzer and record duration time.

**CHANNEL NUMBER

-CH 01 ~ 16

1. SENSITIVITY Adjusts motion Detection Sensitivity.

-1 ~ 32 (low →high)

2. VELOCITY Adjusts motion object slow /fast speed detection

-1 ~ 10 (slow speed→fast speed)

3. ACTIVATION (For each channel)

-ON / OFF. The function only for channel motion detect active, not for motion record per each.

4. RELAY

-ON / OFF

Even choose on, but RELAY SETUP→Motion relay or relay function off, this function is still closed.

5. >MOTION AREA SETUP<



Press direction buttons up/down to choose items.



Press values change button to change values.

> MOTION AREA SETUP <

All area detect with factory default. Press ENTER button to change mode and then increase or reduce.

For example:

Clear lattices



Press value change button to reduce. ◁

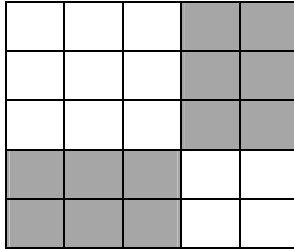
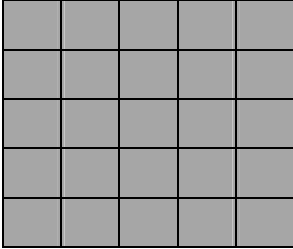

Add lattices



Press value change button to reduce. ▷

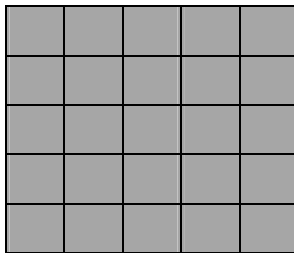
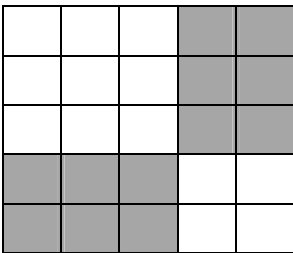

Icon:



Press ▷ to increase all area, press ◁ to reduce all area.

Icon:



Press Up / Down / Left / Right direction key to move, press ▷ to increase lattices; press ◁ to reduce lattices.

Icon: +

Press Up / Down / Left / Right direction key to move and increase area.

Icon: X

Press Up / Down / Left / Right direction key to move and reduce area.

3. RECORD SETUP

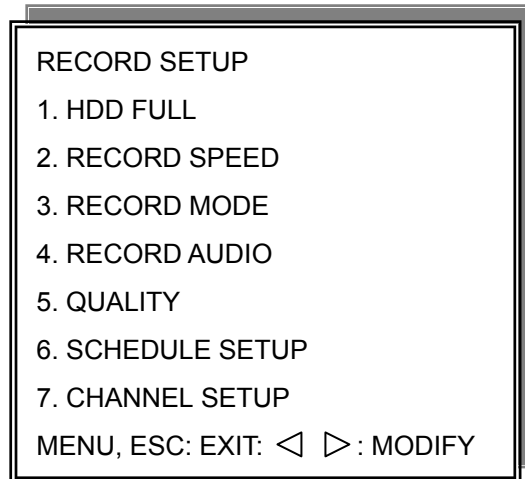
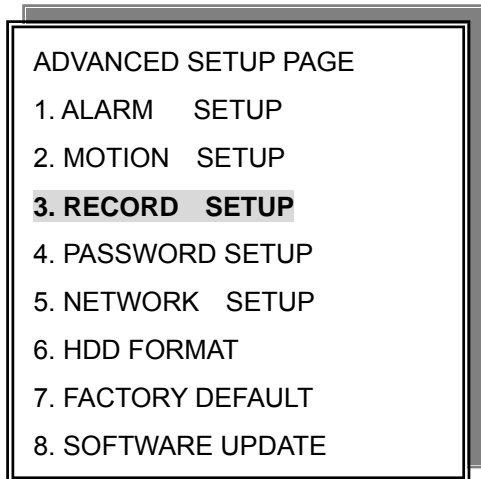

RECORD SETUP

- 1) HDD FULL: When hard disk is full, DVR next step is kept overwrite record or stop record?
 -OVERWRITE / STOP REC

Notice: STOP REC : One hard disk record full, stop record. Two hard disk, both of them record full, stop record.

Record process	OVERWRITE	STOP REC
M(99%), S(0%) → M(100%), S(0%)	To second and record	To second and record
M(99%), S(100%) → M(100%), S(100%)	To second and record	To second and record
M(0%), S(99%) → M(0%), S(100%)	To first and record	To first and record
M(100%), S(99%) → M(100%), S(100%)	To first and record	Stop record

Notice:

When hard disk is full, system buzzer on, and then presses ENTER to stop. Next to press REC, over write message window popup.

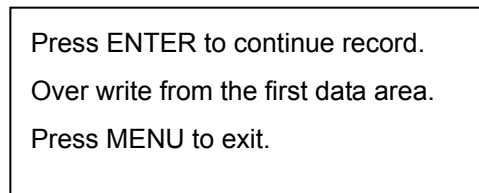
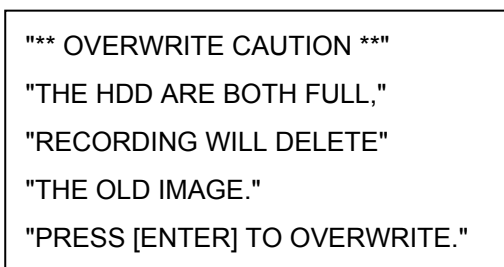

- 2) RECORD SPEED: Record FPS setup
 -1/30(1/30), 1/15(1/15), 1/10(1/10), 1/5 (1/5), 1/3 (1/3), 1/2 (1/2), 1(1), 2(2), 3(3.13), 5(5), 10 (8.33), 15(12.5), 30(25), 60(50), 120(100). NTSC / (PAL)
- 3) RECORD MODE: Record mode setup.
 -ALWAYS / SCHEDULE / EVENT / EVENT ON SCHEDULE / EVENT + SCHEDULE
- 4) RECORD AUDIO: Audio record setup
 -ON / OFF. (Suggest not fewer than 5 fps.)
- 5) QUALITY: Record image quality setup
 - SUPER / HIGH / FINE / NORMAL / LOW
- 6) SCHEDULE SETUP



Press direction buttons up/down to choose item.



Press values change button to change values.

Additional:

2. RECORD SPEED. 1/30(1/30), 1/15(1/15), 1/10(1/10), 1/5 (1/5), 1/3 (1/3), 1/2 (1/2), 1(1), 2(2), 3(3.13), 5(5), 10 (8.33), 15(12.5), 30(25), 60(50), 120(100).

-120 is the maximum fps. Full screen playback with 120 frames per each.

Split screen playback with 60 frames.

3. RECORD MODE. ALWAYS / SCHEDULE / EVENT / EVENT ON SCHEDULE / EVENT + SCHEDULE.

-Always: 24 hours recording.

-Schedule: Date and time schedule recording mode.

-Event: Alarm / Motion / V-Loss event mode recording. (Whatever which channel event, all channel record.)

-Event on schedule: Event record only on schedule time.

-Event + Schedule: Except event on schedule recording, it would still do record if event happens not on schedule time.

Notice:

After record mode setup, user needs to press REC button to start. Set on Always mode, DVR do record if user presses REC. Other record mode would ready on DVR idle status.

4. RECORD AUDIO: ON / OFF.

-Choose on, DVR would do audio recording.

>SCHEDULE SETUP<

RECORD SETUP

1. HDD FULL
2. RECORD SPEED
3. RECORD MODE
4. RECORD AUDIO
5. QUALITY
- 6. SCHEDULE SETUP**
7. CHANNEL SETUP



Press direction buttons up/down to SCHEDULE items.



Press values change button to change values.

Factory default is everyday all schedules time on recording.

SCHEDULE SETUP

CURSOR STEP

30MIN / 6MIN

SUN



MON



TUE



WED

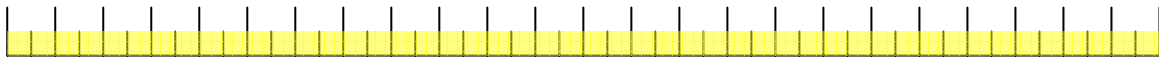

THU

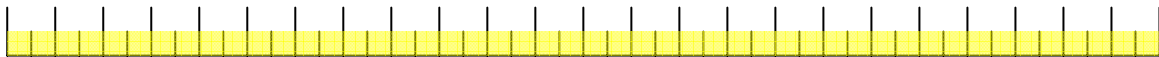

FRI



SAT

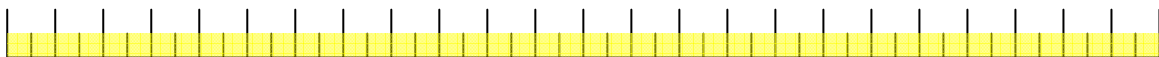

Press direction buttons up/down/left/right to see date and time difference.



Press values change left/right button to change 30MIN or 6 MIN

++ / -- : Increase / Reduce. Every day record with factory default.

On , use up/down button to choose date, press button to change on ++ or --. After, use direction left / right button to start increase or reduce time area.

Mode function button

++ increase

-- reduce

CURSOR STEP

SUN

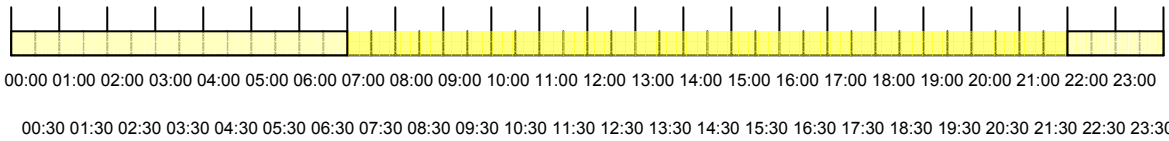

MON

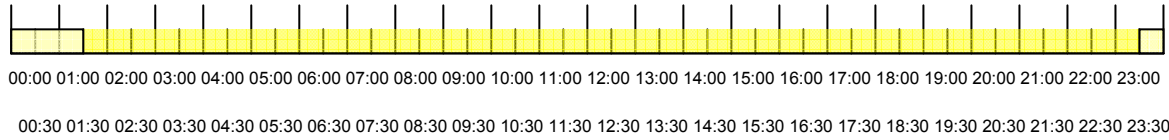

TUE

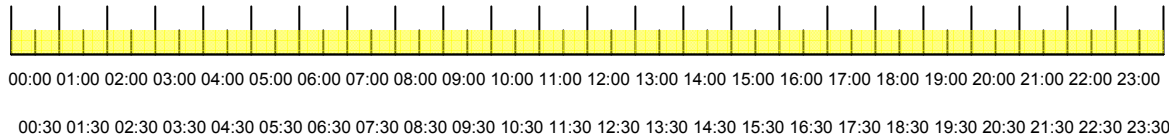

WED

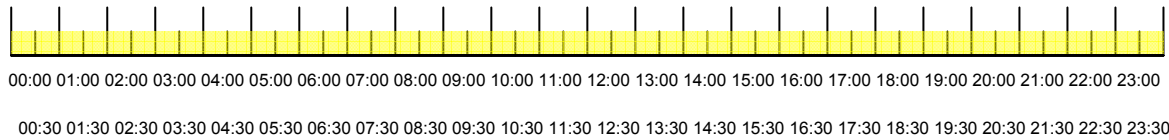

THU

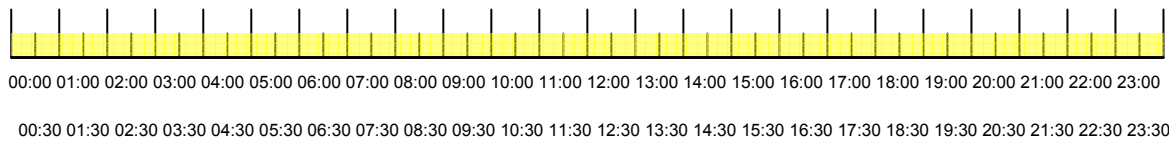

FRI

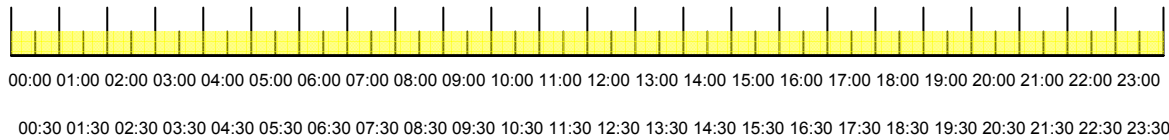

SAT

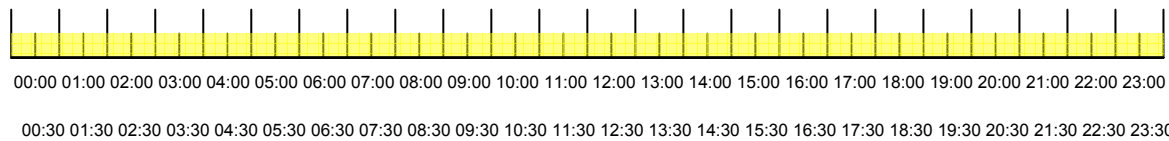

For example: TUE ~ SAT, all day schedule time recording, but SUN 07:00 ~ 22:00 and MON 01:30 ~ 11:30 do schedule recording. User can press ENTER to see the schedule time area difference.

7) RECORD CHANNEL SETUP PAGE

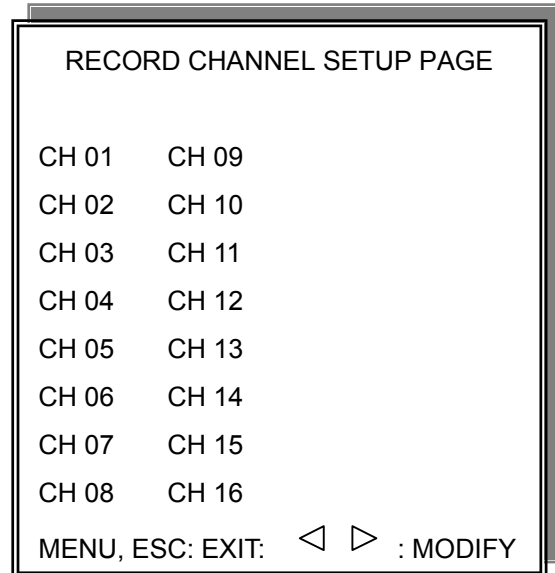
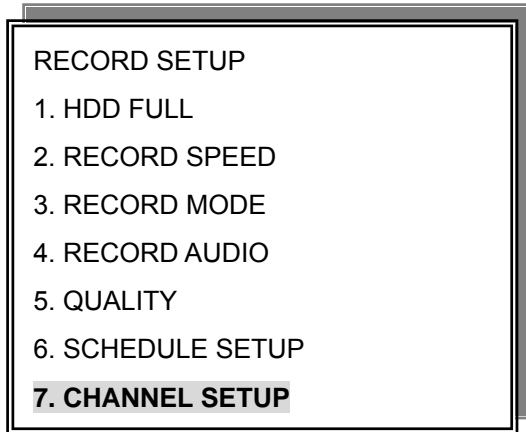

CH 01 : ON / OFF CH 09 : ON / OFF
CH 02 : ON / OFF CH 10 : ON / OFF
CH 03 : ON / OFF CH 11 : ON / OFF
CH 04 : ON / OFF CH 12 : ON / OFF
CH 05 : ON / OFF CH 13 : ON / OFF
CH 06 : ON / OFF CH 14 : ON / OFF
CH 07 : ON / OFF CH 15 : ON / OFF
CH 08 : ON / OFF CH 16 : ON / OFF

PS. Choose off if no video input channel or which channel would not do record.

According to channel record, record time would different.



Press direction buttons up/down to choose item.



Press values change button to change values.

4. PASSWORD SETUP

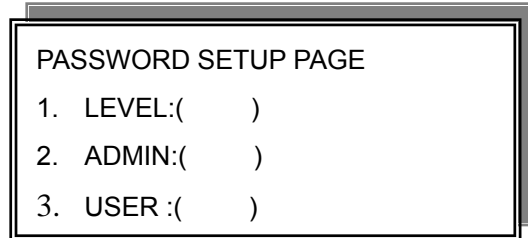
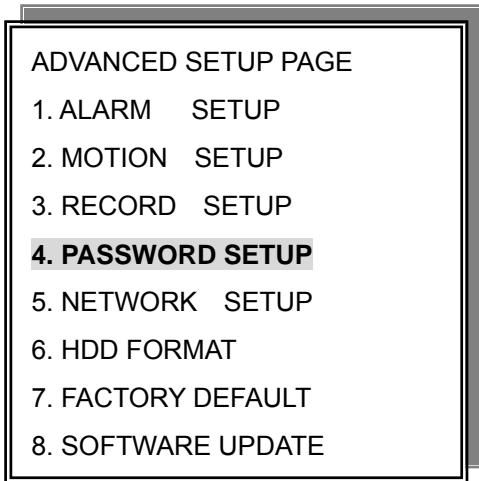

- 1) LEVEL (Log In level ID type setup)
>NONE / ADMIN / USER



Press direction buttons up/down/left/right to
Choose items position.

-ADMIN

-USER



Press values change button to change values.

-NONE, user does not need to insert password before enter in MENU.

- 2) ADMIN password
>44444 (Factory Default)

Notice:

- 3) USER password
>11111 (Factory Default)

Password always 5 character input, cannot < 5 characters



Press direction buttons up/down/left/right to choose items position.

Press numeric (1 ~ 10)button or remote controller (1 ~ 10)to choose

Notice:

1. ADMIN level can setup all DVR menu functions.
2. USER level cannot setup ADVANCED page of DVR main menu function.
3. Auto disappear after 4 minutes if no any manual operate.

5. NETWORK SETUP

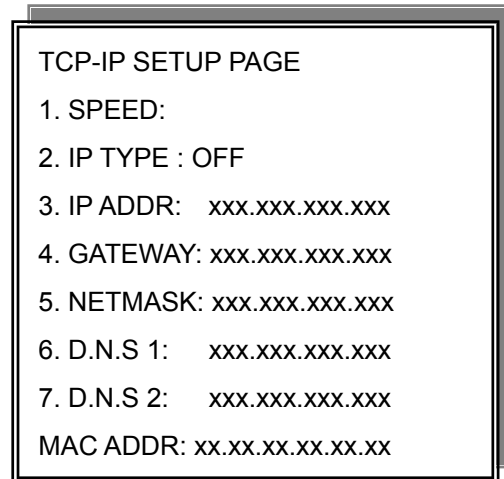
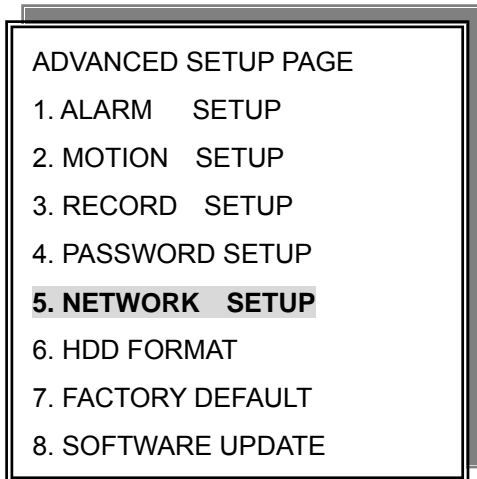

1. SPEED : >512K / 512K / 256K / 128K / 64K
> Upload speed. Choose the close speed by applied.
 2. IP TYPE: OFF
> OFF (Close network function) / STATIC (LAN / WAN)
 3. IP ADDR: 192.168.192.250 (Factory Default)
 4. GATEWAY: 192.168.192.001 (Factory Default)
 5. NETMASK: 255.255.255.000 (Factory Default)
 6. DNS 1: xxx.xxx.xxx.xxx
 7. DNS 2: xxx.xxx.xxx.xxx
> Into address if network company provide.
- MAC ADDR
XX.XX.XX. Machine number, user cannot change.



Press direction buttons up/down/left/right to TCP-IP items position.



Press values change button to change values.

>Network Requirement: DVR can not go through IP sharing device, only HUB.

LAN (Local Area Network)

- 1) DVR side input local IP address such as 192.168.192.5, or use the factory default IP.
- 2) After DVR network setting, install the remote viewer to computer. Computer network IP also need to setup on local IP address such as 192.168.192.6. DVR and computer IP address cannot equal.
>PC→DVR: need a cross-link cable.

WAN (World Area Network)

- 1) User apply static IP from network company, then input IP Gateway, and Subnet mask address to DVR TCP-IP setup.
- 2) Advice user apply network speed Upload 512K / Download 512K, to avoid image data too big influence the remote quality. The network traffic jam always make data transfer slow, it is normal.
- 3) After DVR TCP-IP setup, install the remote viewer to computer. See the network page.

6. HDD FORMAT

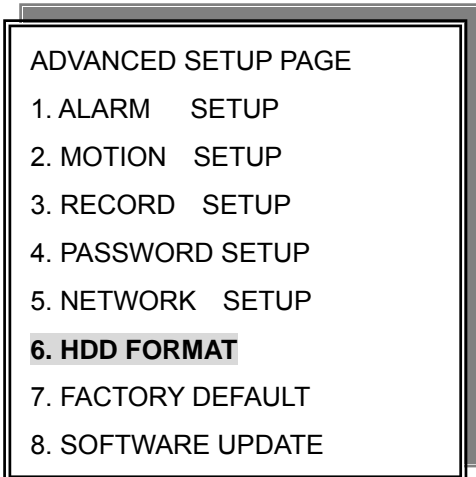

Press direction buttons up/down to
HDD FORMAT items position.
Press ENTER to format all HDD.

Caution: User can format HDD only when
all HDD stop record or playback.

→ HDD FORMAT CAUTION!! :

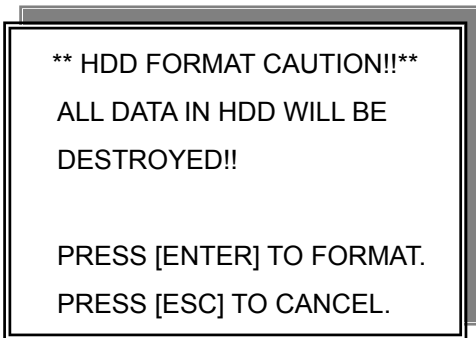

Press ENTER button to format hard disk.



Press ESC button to cancel hard disk format

Notice:

New hard disk detect: When DVR power, system would detect new hard disk install. If the hard disk is in different format, then the message popup. User needs to press ENTER to format, if press MENU, and then this hard disk would not be detected.

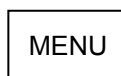
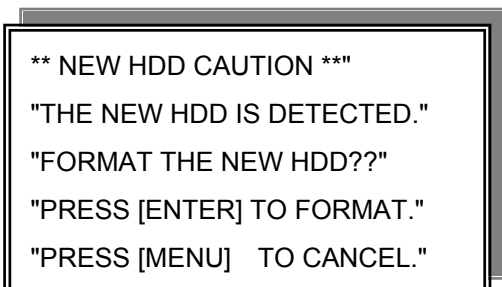

Press FORMAT to format.
Press MENU to exit.

7. FACTORY DEFAULT

ADVANCED SETUP PAGE
1. ALARM SETUP
2. MOTION SETUP
3. RECORD SETUP
4. PASSWORD SETUP
5. NETWORK SETUP
6. HDD FORMAT
7. FACTORY DEFAULT
8. SOFTWARE UPDATE



Press direction buttons up/down to FACTORY DEFAULT items position.
Press ENTER to restore.

**** CAUTION!! ****
ALL SETUP VALUE WILL BE CLEAR,
AND RESTORE FACTORY DEFAULT!!

PRESS [ENTER] TO RESTORE.
PRESS [ESC] TO CANCEL.



Press ENTER button to restore.



Press ESC button to cancel.

8. SOFTWARE UPDATE

ADVANCED SETUP PAGE
1. ALARM SETUP
2. MOTION SETUP
3. RECORD SETUP
4. PASSWORD SETUP
5. NETWORK SETUP
6. HDD FORMAT
7. FACTORY DEFAULT
8. SOFTWARE UPDATE

SOFTWARE UPDATE
UPDATE METHOD:

START UPDATE

UPDATE METHOD: USB / HTTP / UNIX

USB: Copy firmware to USB device, and then plug in DVR USB interface. Choose START UPDATE and then press ENTER to start. Or save the update version to USB device, DVR system would do data update automatically. USB ERROR displays if no any USB device plug.

NETWORK: Press START UPDATE to link. 80 Port must open in your network server.

UNIX: For R&D testing.

USB Data Read and Networking

1. Windows 2000 / XP, select small character display.
2. Resolution 1024 x 768.
3. RAM up to 128 MB, system up to PIII-800.
4. Double click SETUP.EXE of CD, and then start to install.
5. User can go to company server to download AP software.



6. Browse install path and then click Next.

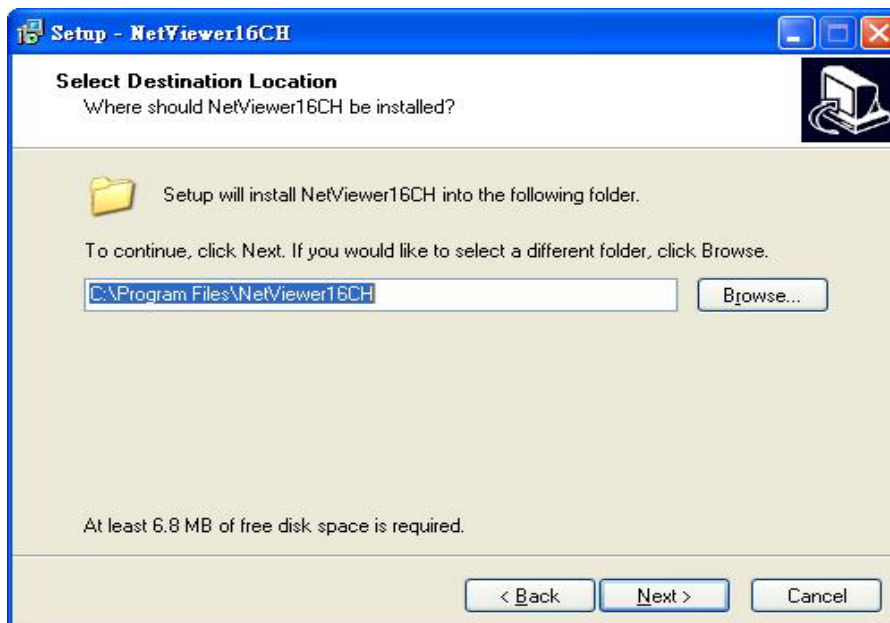

7. Advice resolution 1024 x 768. According computer equipment, please choose suitable resolution

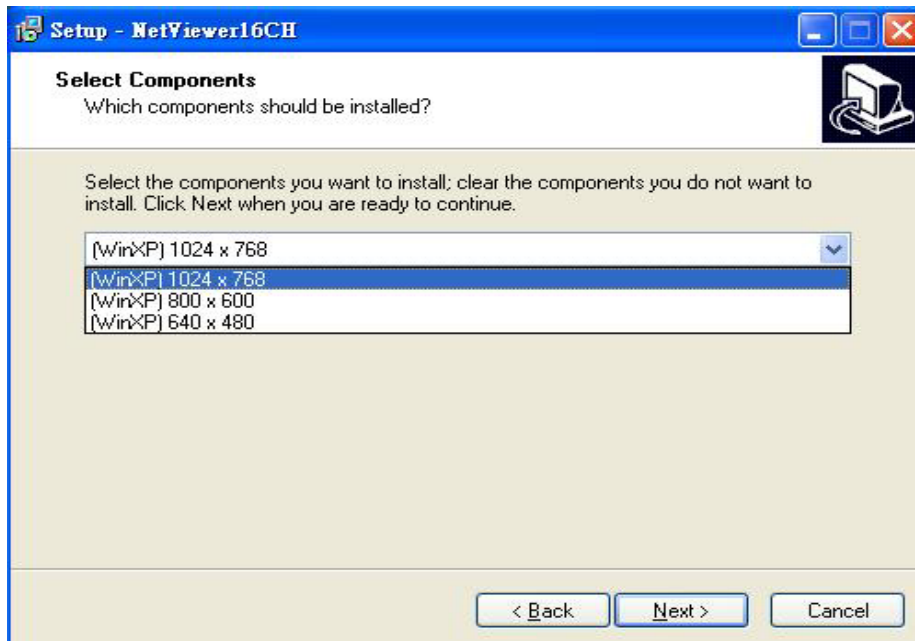

8. Select Start Menu Folder, and then click Next.

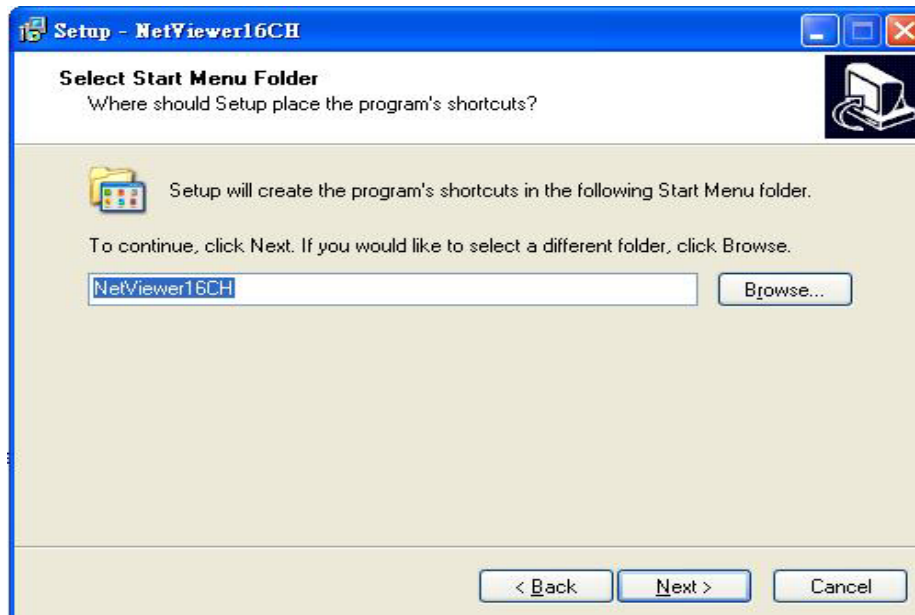

9. Click create a desktop icon or not, and then click Next.

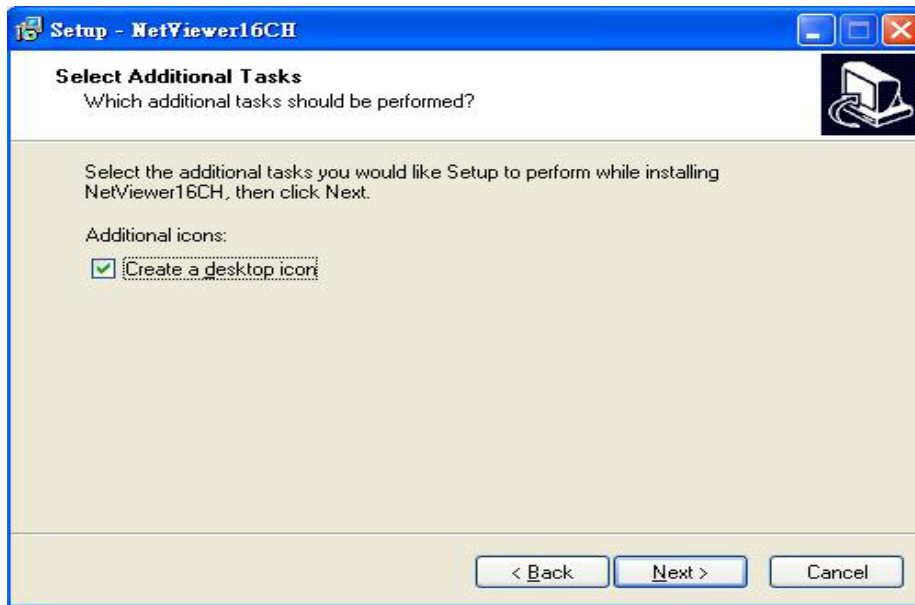

10. Click INSTALL to start install.

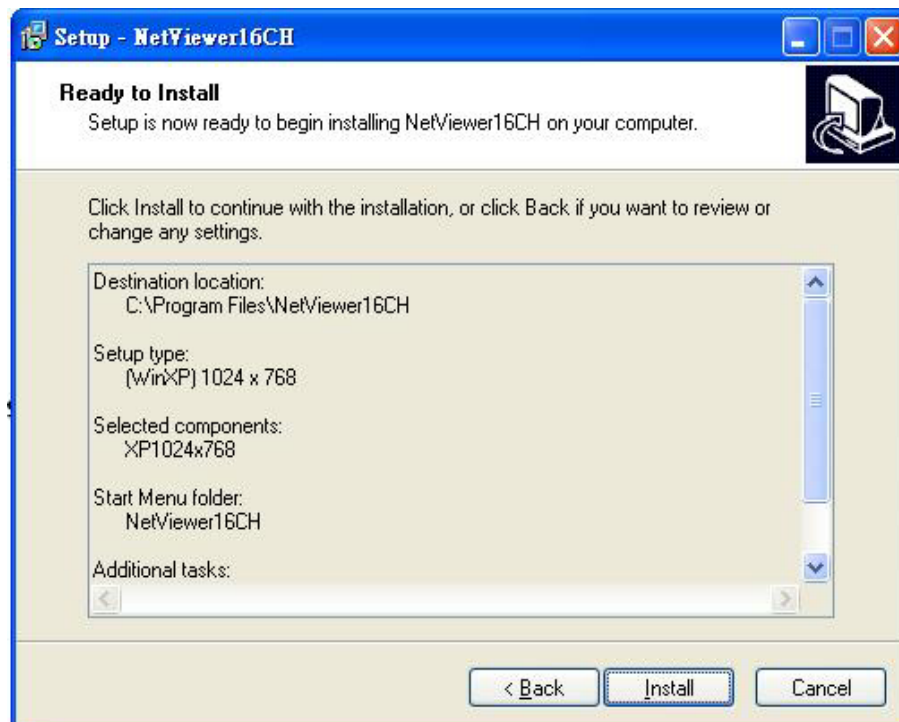

11. Click Launch NetViewer 16CH and click Finish to done.



12. Click Setting.

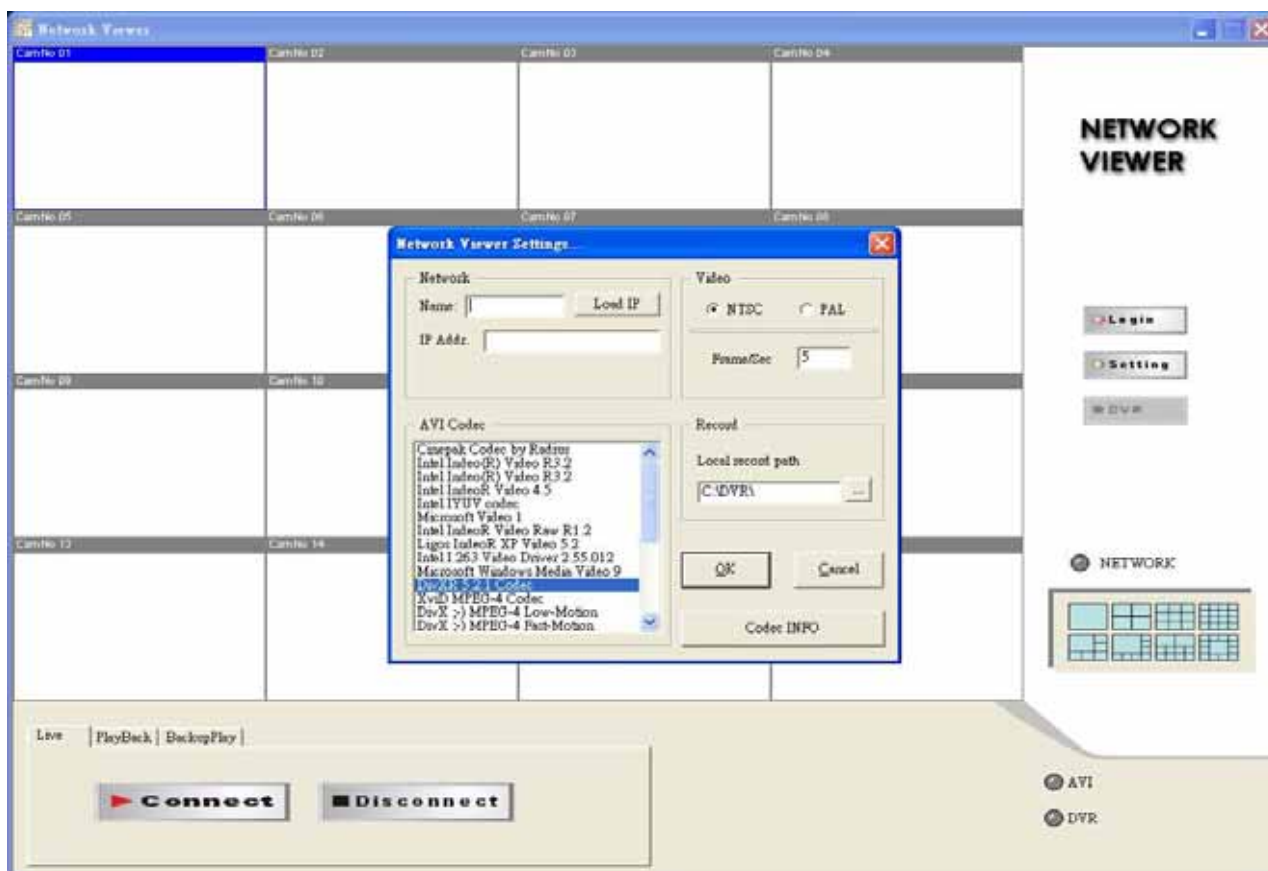

Name: Name the IP address position.(Each name and IP saves every different input)

IP Addr: Input DVR IP address.

AVI codec: Different computer equipment; different AVI format.

Microsoft Windows Media video 9 is better.

Or Cinepak Codec by Radius / Microsoft Video 1.

Video: Fullsize, Halfsize: screen size choose.

NTSC, PAL. Frame/Sec: Video system choose. Record frame choose.

Click OK to confirm.

On Live / PlayBack , click DVR to save action pictures, *.DVR file. It needs this software to play.

Browser, Local record path could change. The path user changes is for .DVR save, *JPG file is always C:\DVR

- Press DVR to start record .DVR file(DVR LED green on.), press again to stop.

13. Click Login, depends on limits of authority. (ID / password is same as DVR)

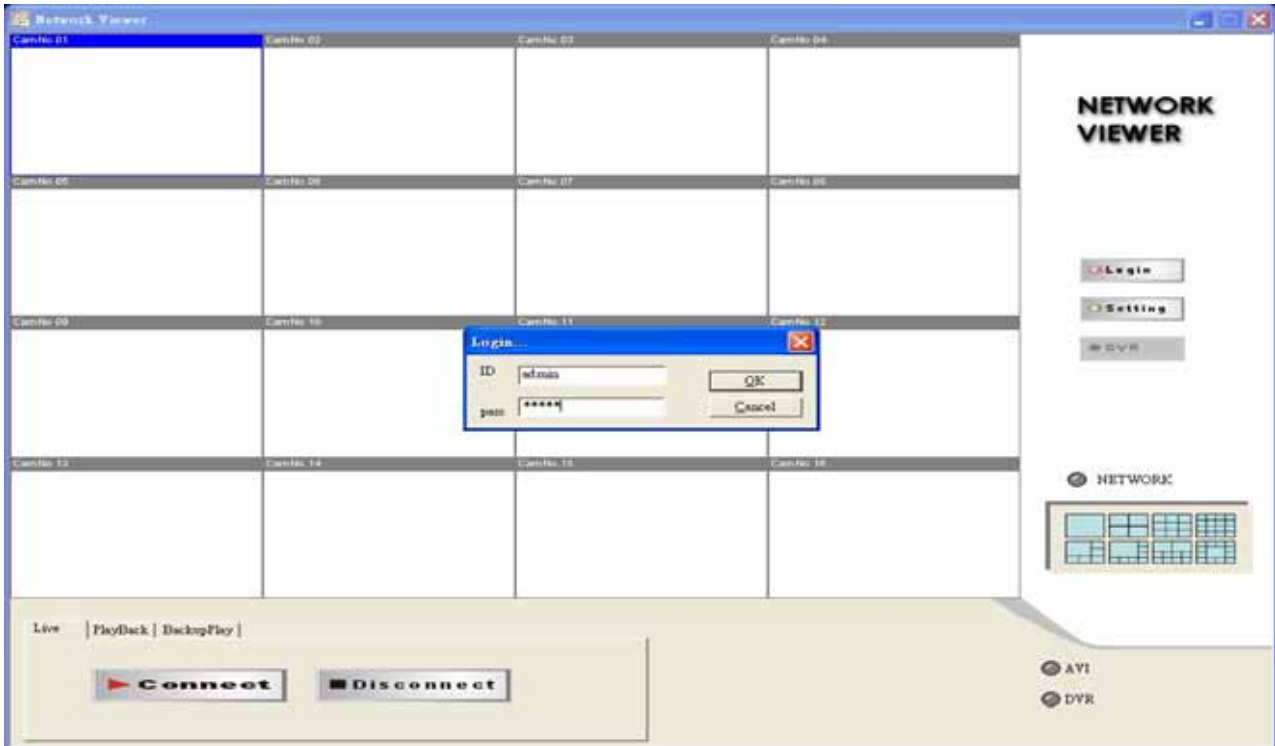

Factory ID is user login. Input admin if you are an administer. Must input on little character.

Factory: Password, admin : 44444, user : 11111. Password displays when log in, user just needs to input ID.

User log in, no PlayBack function authority. Total 6 people log in. Admin x 1, user x 5.

Click OK, after about 5 seconds, admin login!! Message popup. And then click Connect to start.

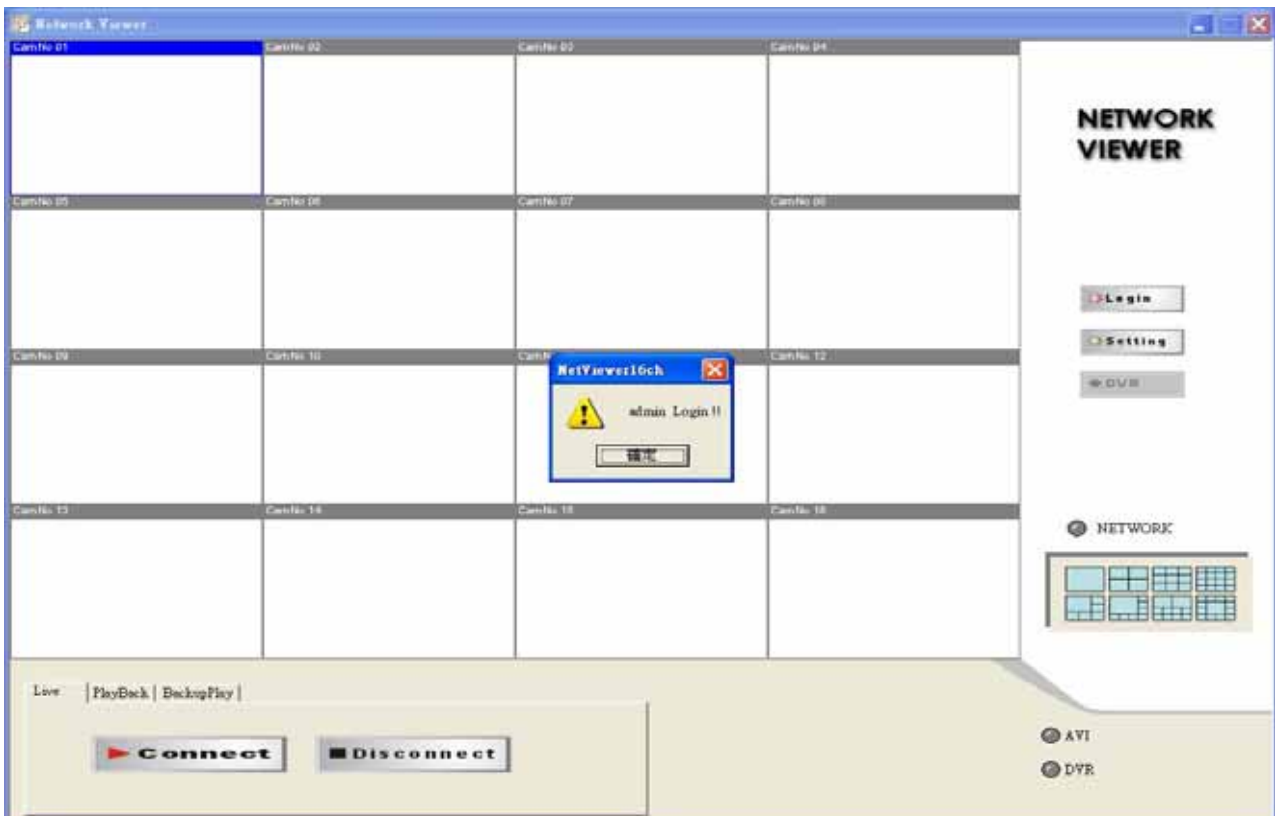

14. Click Connect, after about 2 ~ 3 seconds to start connect LAN or WAN. Click Disconnect to stop. If the NETWORK is connecting success, the blue light would keep glisten Else, blue is always on light or not display, the connecting is failed.



Click live / PlayBack / BackPlay mode.

Live: DVR live watching.

PlayBack: Change to playback mode. After 2 ~3 seconds to change.

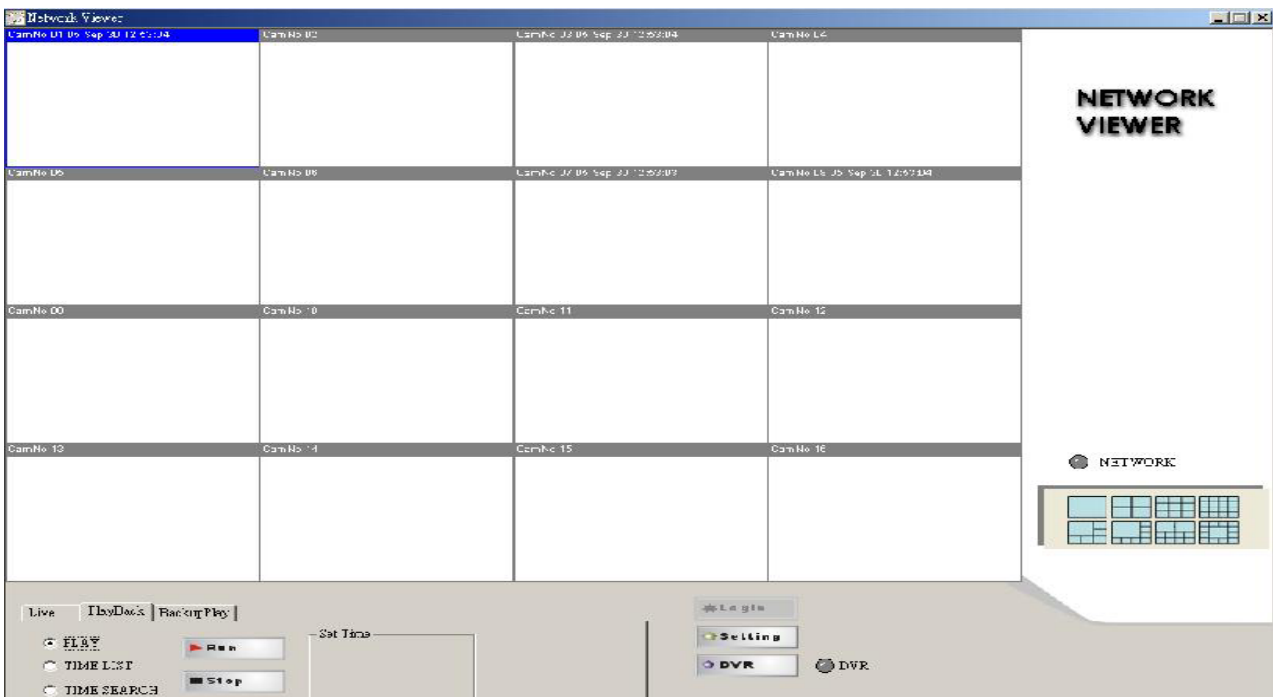

PLAY: Click RUN around 2 ~ 30 seconds to start play first record. If over 30 seconds, cannot find any file or network disconnect, Time out message popup. Please try again play or connect again. Click STOP to end playback.

TIME LIST: Click RUN, time lists popup. On the item, double click date and time to start play, around 2 ~ 30 to start play first record. If over 30 seconds, cannot find any file or network disconnect, Time out message popup. Please try again play or connect again. Click STOP to end playback.

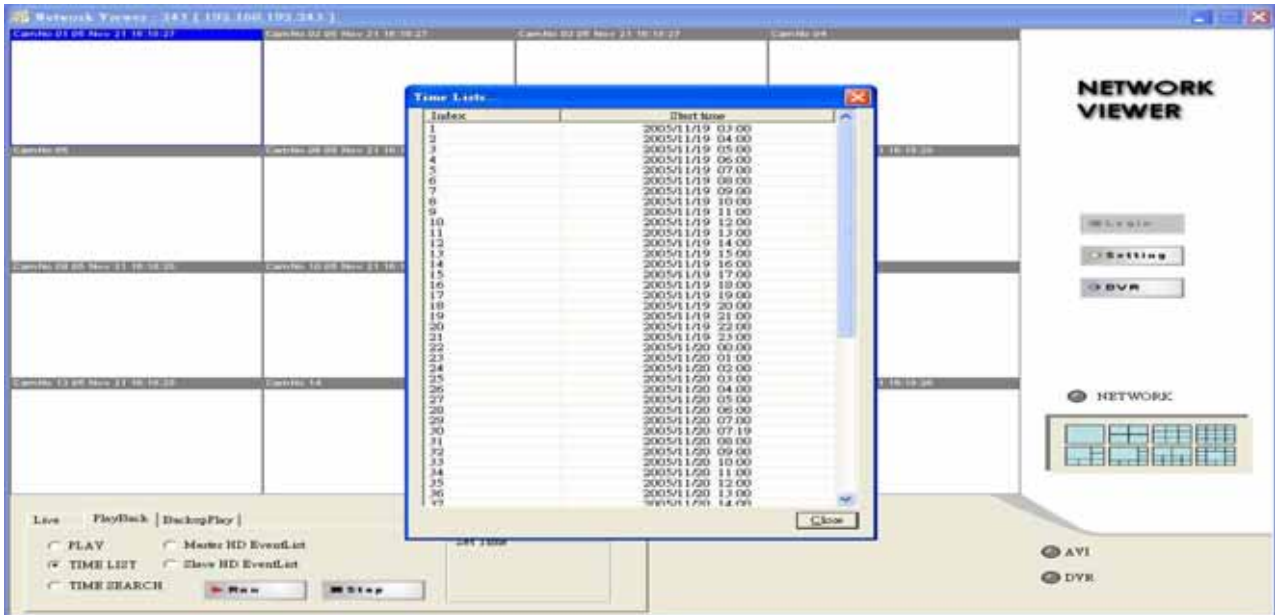

TIME SEARCH: Chose date and time, click RUN, around 2 ~ 30 seconds to start play first record. If over 30 seconds, cannot find any file or network disconnect, Time out message popup. Please try again play or connect again. Click STOP to end playback.

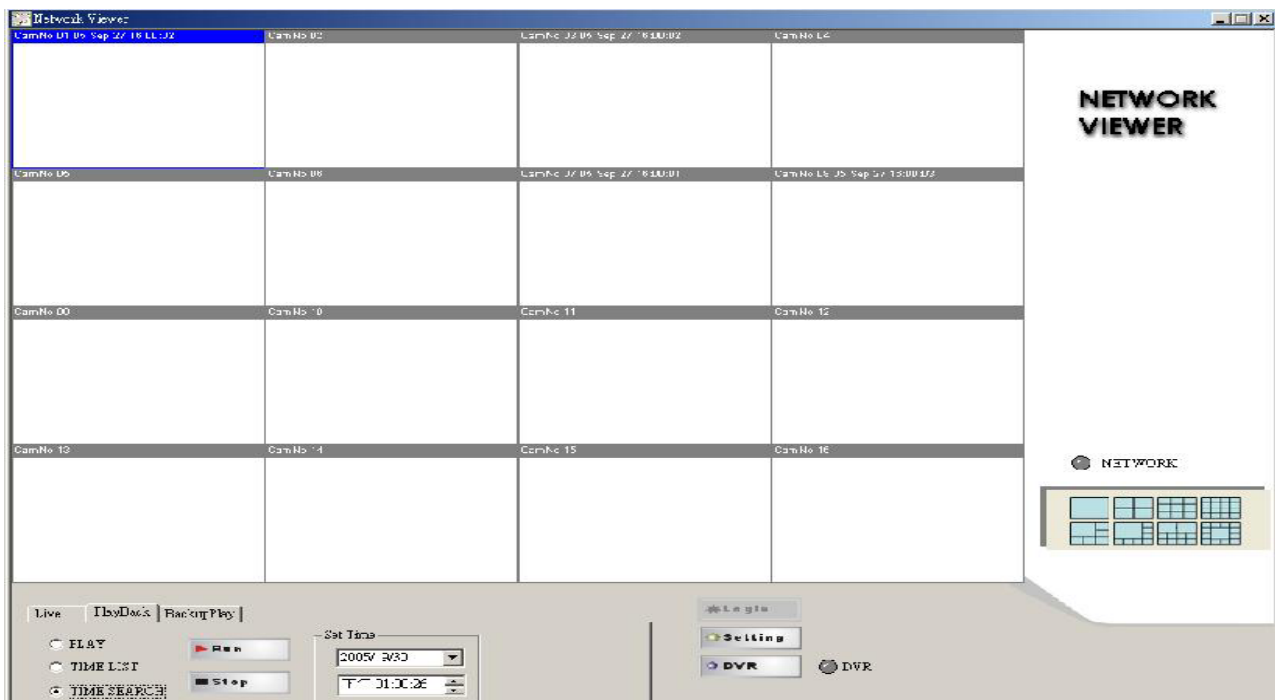

Notice: PLAY / TIME LIST / TIME SEARCH change, needs to stop play first.

-Master HDD Event Lists:

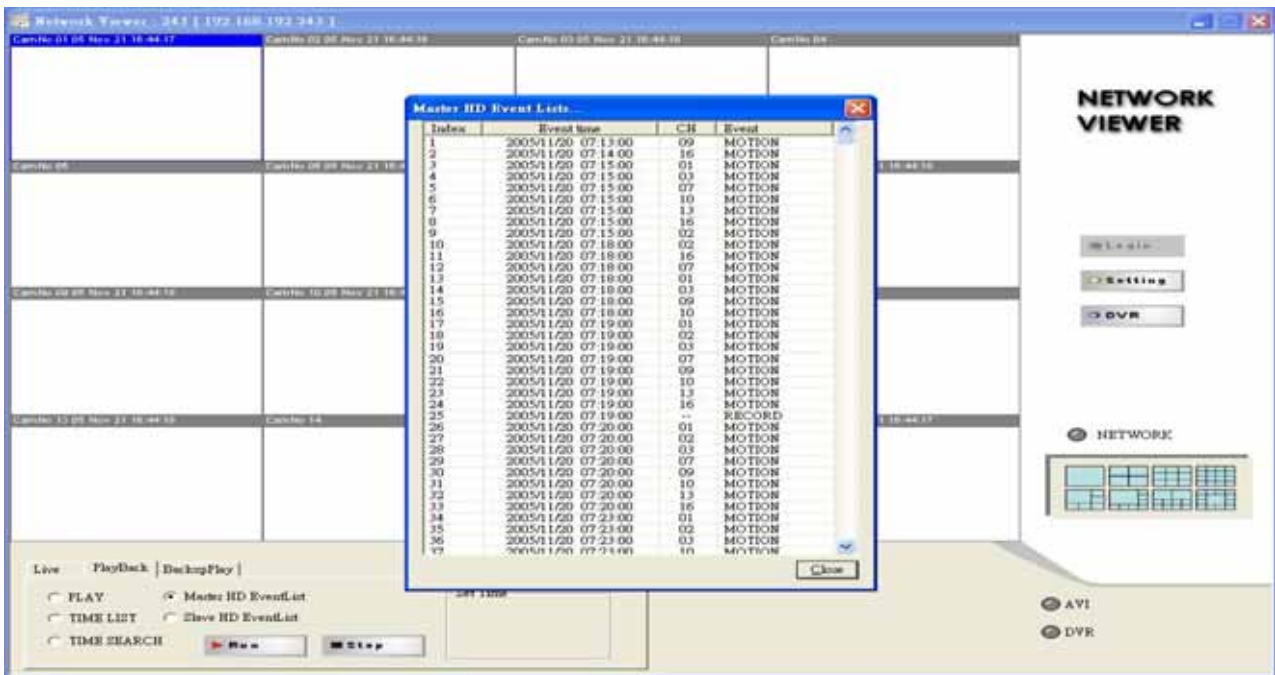

-Slave HDD Event Lists:

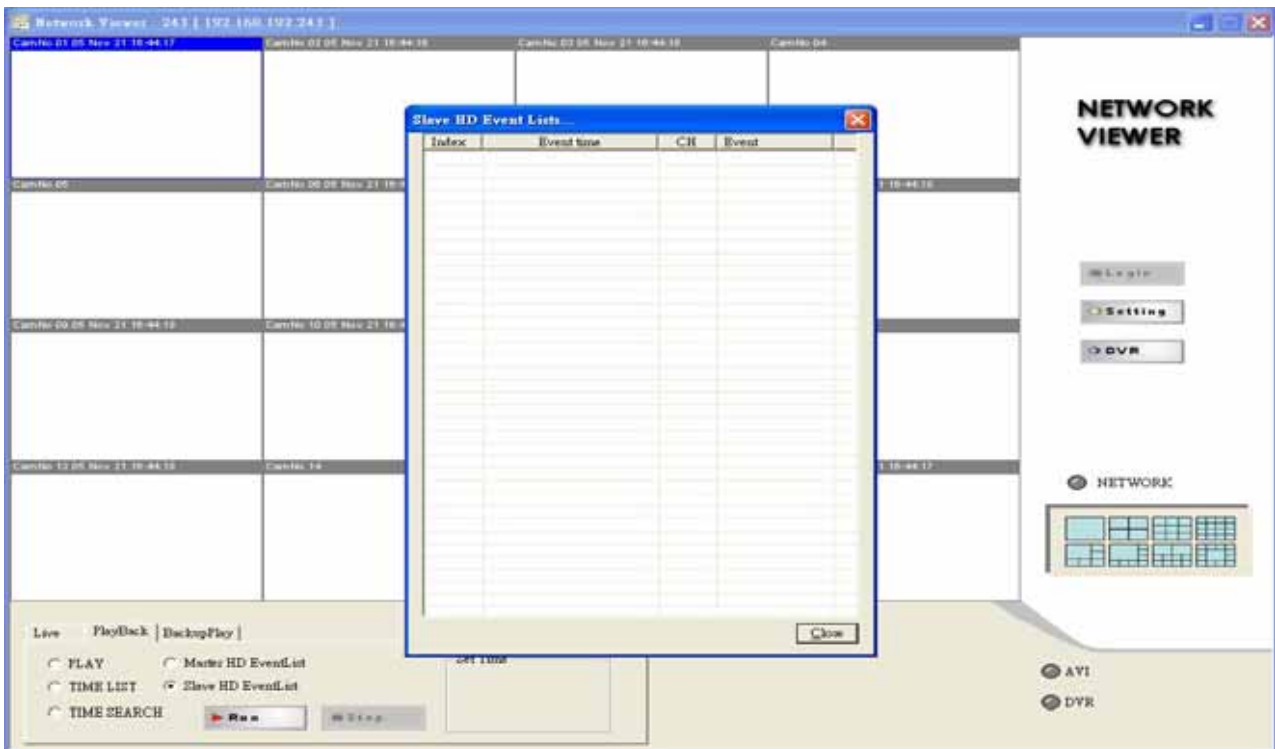

Click RUN, time lists popup. On the item, double click date and time to start play, around 2 ~ 30 to start play first record. If over 30 seconds, cannot find any file or network disconnect, Time out message popup. Please try again play or connect again. Click STOP to end playback.

15. BackupPlay:

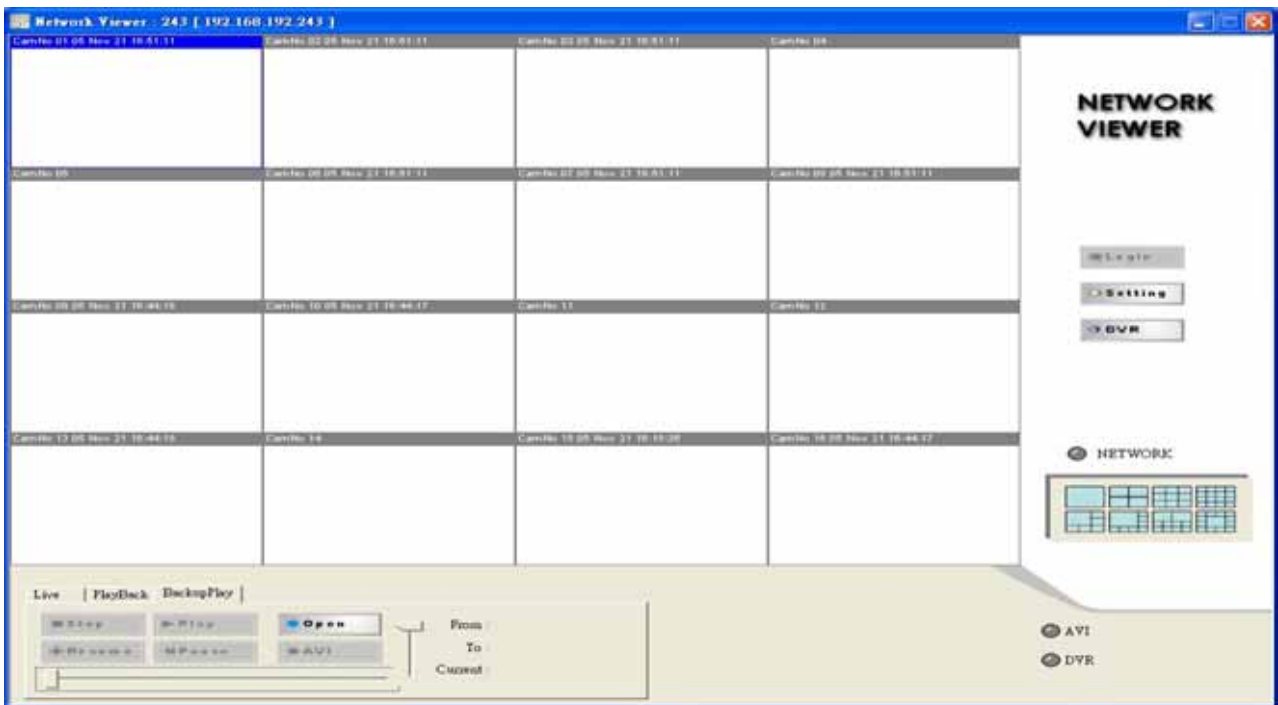

- Click Open to choose file path.

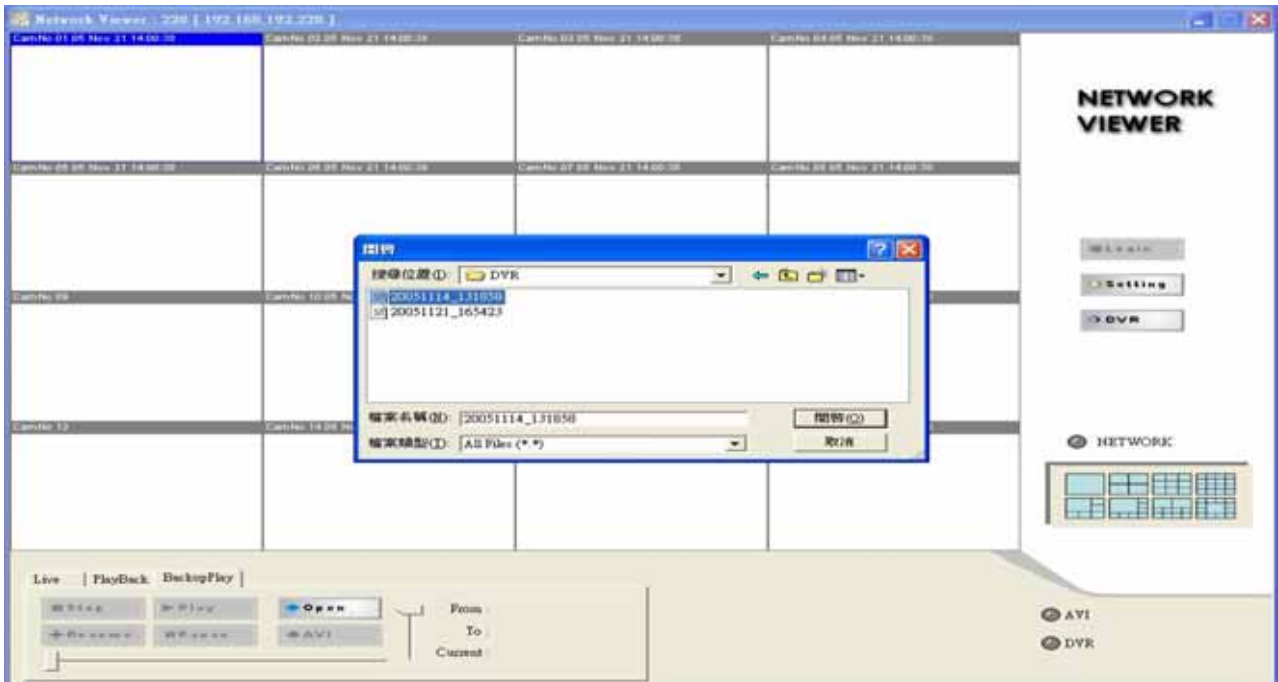

Click Play to start backup data play. Click Stop to end. Click Pause to temporary stop playback. Click Resume to restart.



Choose camera, click mouse right button. Camera 1 ~ 16 switches or reset all. Click Save "CamNo xx image" / save image all to save current image. Save path is C:\DVR.

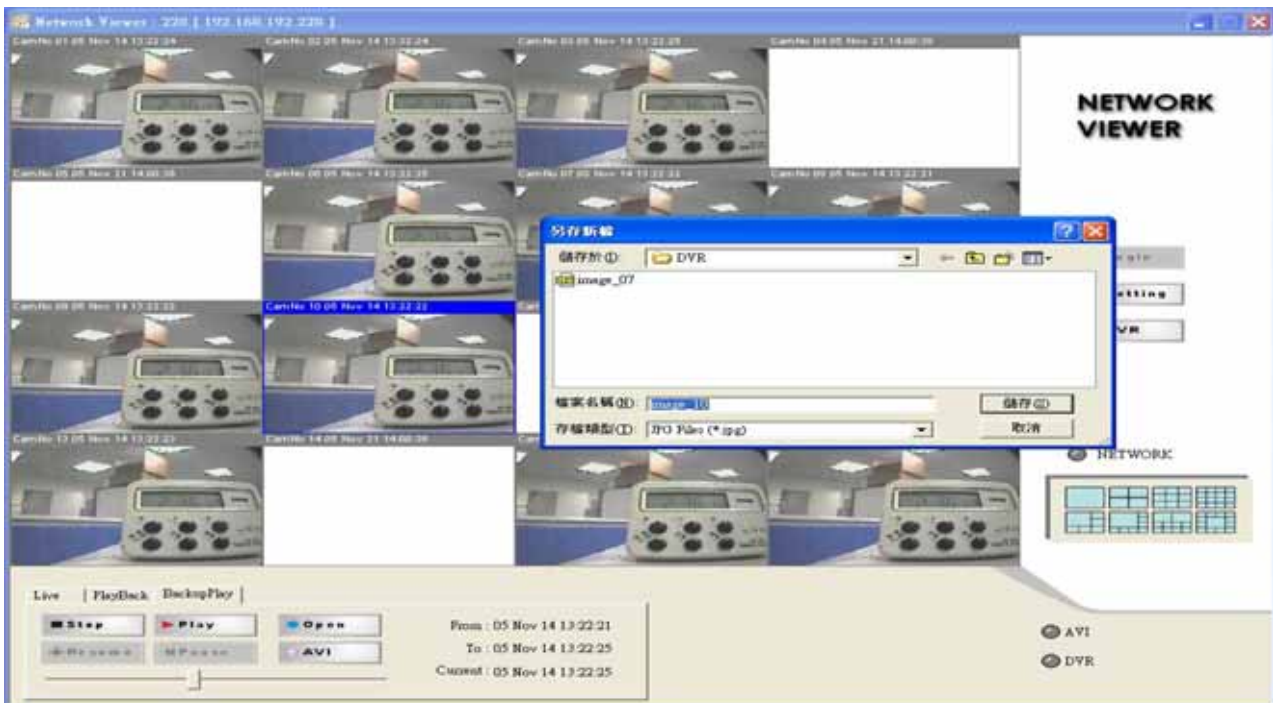

16. AVI transfer: Click BackupPlay

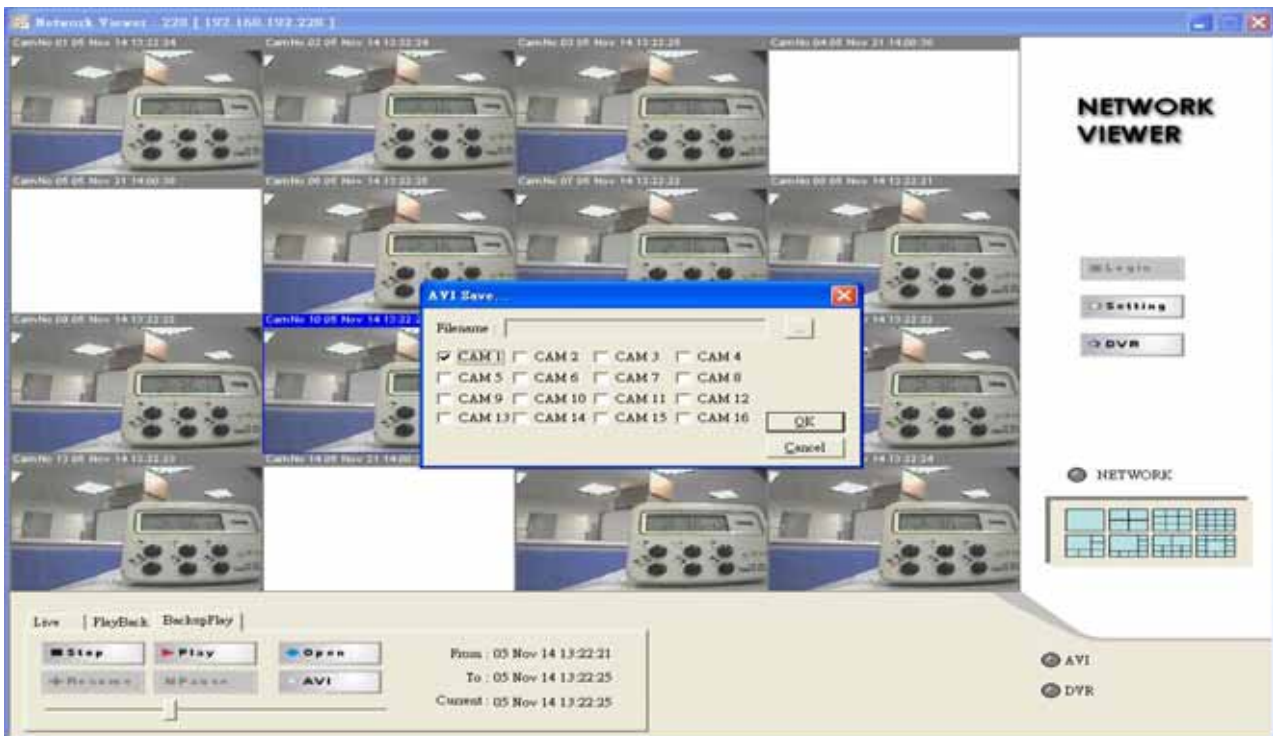

AVI : On live or playback mode, save files to .DVR file. And then OPEN file, press play to start playback. Press AVI button to start record AVI file. Press again to stop.

Only 2 cameras selectable. A warning message appears if user selects over 3 cameras,

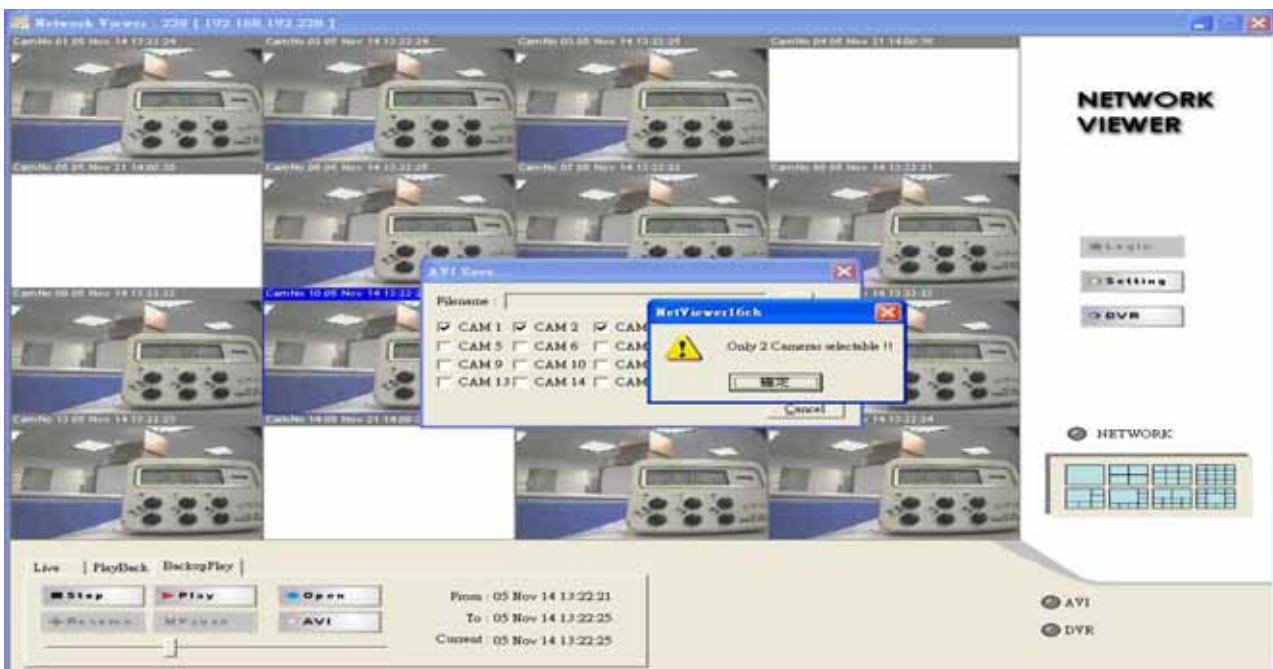

Record Time Table: 80GB HD

Record Quality: Low. KB Range: Lowest: 13, Highest: 20. Average: 17.

REC FPS	120	60	30	15	10
REC Hour	11	22	45	91	137
REC FPS	5	3	2	1	1/2
REC Hour	274	456	685	1370	2741
REC FPS	1/3	1/5	1/10	1/15	1/30
REC Hour	4112	6853	13706	20565	41140

Record Quality: Normal. KB Range: Lowest: 14, Highest: 25. Average: 20.

REC FPS	120	60	30	15	10
REC Hour	9	19	38	77	116
REC FPS	5	3	2	1	1/2
REC Hour	233	388	582	1165	2330
REC FPS	1/3	1/5	1/10	1/15	1/30
REC Hour	3495	5825	11650	17479	34967

Record Quality: Fine. KB Range: Lowest: 15, Highest: 28. Average: 22.

REC FPS	120	60	30	15	10
REC Hour	8	17	35	70	105
REC FPS	5	3	2	1	1/2
REC Hour	211	353	529	1059	2118
REC FPS	1/3	1/5	1/10	1/15	1/30
REC Hour	3177	5295	10591	15890	31787

Record Quality: High. KB Range: Lowest: 17, Highest: 30. Average: 24.

REC FPS	120	60	30	15	10
REC Hour	7	16	32	64	97
REC FPS	5	3	2	1	1/2
REC Hour	194	323	485	970	1941
REC FPS	1/3	1/5	1/10	1/15	1/30
REC Hour	2912	4854	9709	14563	29127

Record Quality: Super. KB Range: Lowest: 19, Highest: 45. Average: 32.

REC FPS	120	60	30	15	10
REC Hour	6	12	24	48	72
REC FPS	5	3	2	1	1/2
REC Hour	145	242	364	728	1456
REC FPS	1/3	1/5	1/10	1/15	1/30
REC Hour	2184	3640	7281	10922	21845

Actual recording time is base on live environment. This table only for reference.

VGA Description (Optional)

Accessories:

1. 20 PIN Male to Female D-SUB pin cable X 1
2. VGA PCB bracket X1
3. Screws X4

1. VGA board introduction.

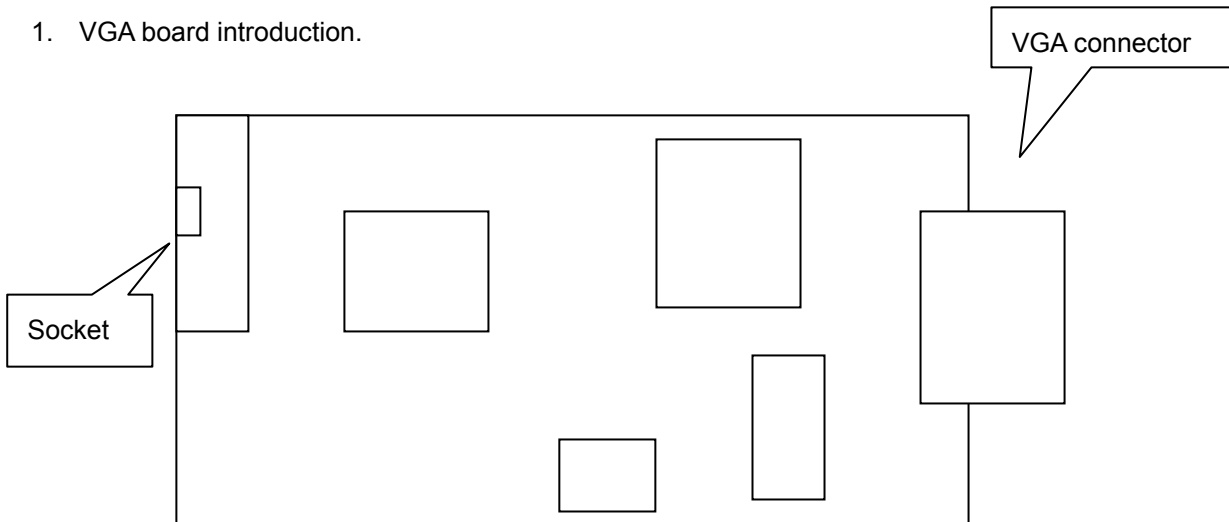

2. Resolution switcher table

Pin 4	Resolution	Pin 1	Pin 2	Pin 3
	640X480 60HZ	ON	ON	ON
	800X600 60HZ	ON	ON	OFF
	1024X768 60HZ	ON	OFF	ON
	640X480 75HZ	ON	OFF	OFF
	800X600 75HZ	OFF	ON	ON
	1024X768 75HZ	OFF	ON	OFF

Resolution and switcher description.

Step. 1	DVR Power on. NTSC / PAL auto detects.
Step. 2	Pin 4 no used
Step. 3	Pin 1 ~ 3 switcher resolution. Do not need to power off DVR.

Additional

Hard Disk x 2 can be installed on DVR base. Both are 2-iron slices immobile type.
2 Iron slices are in the accessories box, please tell supplier if slices are not exist

2-iron slices immobile type:

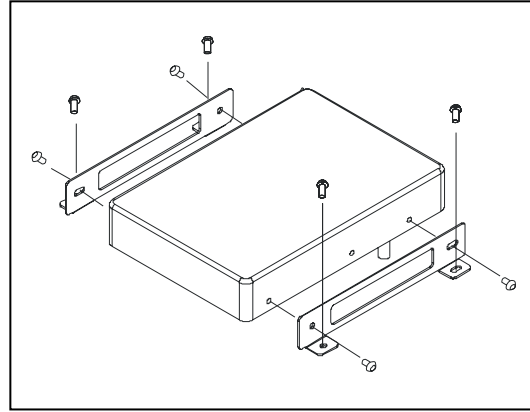
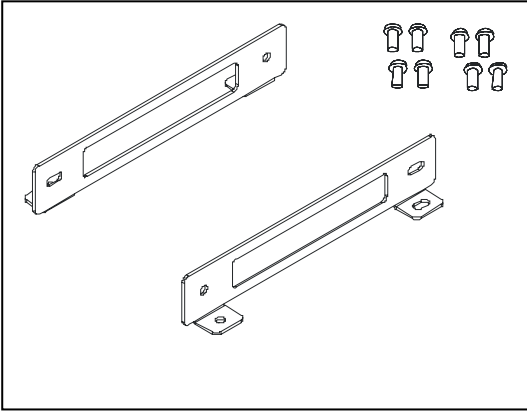

Slices immobile type: 4 screws hole on each slice. 2 for DVR base fixed. Another 2 for hard disk fixed.

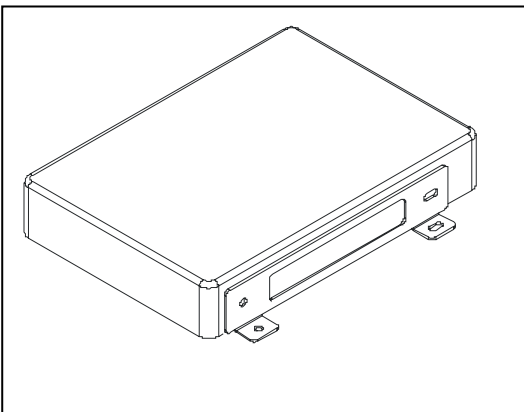

Hard disk install.: Locking hard disk screws, then locking DVR base screws to fixed on.

P / T / Z Dome mode. (Optional)

6. ADVNAGED SETUP PAGE → P.T.Z SETUP

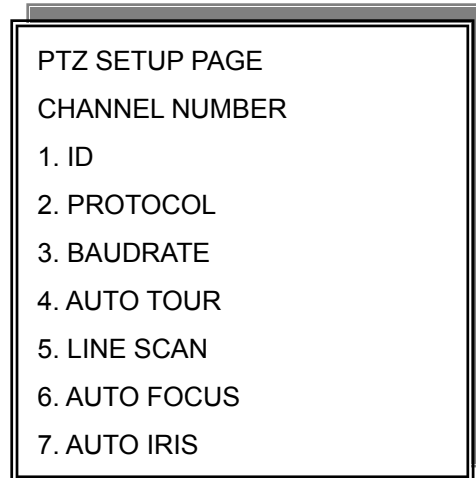
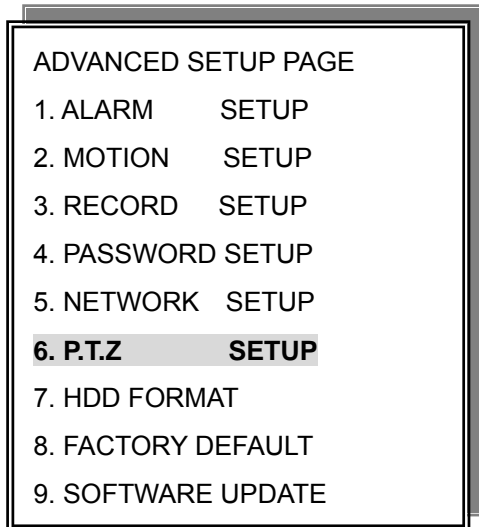

PTZ SETUP PAGE

CHANNEL NUMBER: CH01 ~ CH16

1. ID: 01 ~ 16
2. PROTOCOL: PELCO-P / PELCO-D / LILIN / ABC / OFF
3. BAUDRATE: 1200 / 2400 / 4800 / 9600
4. AUTO TOUR: ON / OFF
5. LINE SCAN: ON / OFF
6. AUTO FOCUS: ON / OFF
7. AUTO IRIS: ON / OFF

After PTZ setup done, go back to live mode. Press W.M. button to PTZ mode.



Icon displays beside date and time caption. To use direction button left/right/up/down

to move PTZ Dome. PTZ Dome can not be control on split screen.

PS. Because the P / T / Z Dome setup is independent by channel and ID, user does not worry about the different ID / Protocol / Baud Rate would affect DVR controls P / T / Z dome error. Just make sure channel and ID / Protocol / Baud Rate corresponding is correct.

Front Panel Button Comparison:

W.M.: To P / T / Z mode

PLAY / REC = IRIS off / IRIS open

◀ ▶ = FOCUS near / FOCUS far

BACKUP / T-SRH = ZOOM IN / ZOOM OUT

MENU = P / T / Z Dome Menu

FRE. : To Preset mode. PRESET: 000 glisten on left-up corner. Moves P / T / Z dome to the position user wants.

When "PRESET: glistening", press number button.

EX: 1 ~ 9. 10 = 1 + 10, 11 = 1 + 1, 12 = 1 + 2, 21 = 2 + 1, 132 = 1 + 3 + 2.

ZOOM : After press ZOOM button to save the presets.

INFO : Press FRE. button into preset mode. When "PRESET: glistening", press number button, and then press INFO to call preset.

AUTO : Press FRE. button into preset mode. When "PRESET: glistening", press number button, and then press AUTO to clear preset.

IE Networking Software

1. This web is for preliminary IE browser.
2. User can download the network viewer from this web page or view the DVR video image in the future.
3. The AP software is already saved to DVR system IC. User needs to do is:
 - a.) Go to Advanced Setup→ Network Setup→Sets LAN or WAN IP address of DVR.
 - b.) Open IE browser, and then into your IP on the IE address bar.
 - c.) If LAN or WAN connects ok, the 16 Channel Digital Video Recorder web page displays like under:

